



HOME STYLE PATTERN BOOK

# Tudor

---

An Old World Selection from the Andersen Style Library



## HOME STYLE PATTERN BOOK

# Tudor

---

An Old World Selection from the Andersen Style Library

Tudor Style Home Overview .....	4
Quintessential Windows & Doors .....	6
Colors & Finishes.....	8
Primary Windows.....	10
Accent Windows.....	11
Window Groupings.....	12
Sash & Grille Design.....	14
Grille Patterns.....	15
Door Proportions.....	16
Entries with Trim.....	17
Window & Door Hardware.....	18
Exterior Trim Style Elements .....	20
Interior Trim Style Elements.....	22
Interior Room Trim Examples .....	24
Product Index .....	25



### **THE ANDERSEN® ARCHITECTURAL COLLECTION**

The Architectural Collection is an industry-leading, innovative approach to windows and doors that's based not on the type of window or door, but rather on the style of home you want to create.

Consisting of Andersen® A-Series and E-Series products, the collection offers two approaches to attaining authentic architectural style.

A-Series products were designed in conjunction with leading architects. These windows and doors feature a unique system of options that work seamlessly together, allowing you to produce virtually any style with ease.

E-Series windows and doors are made to your exact specifications and give you unmatched design freedom within the architectural style you've chosen. They allow you to create dramatic shapes and sizes, and feature 50 standard colors, custom colors, plus a wide range of interior wood species.

With the Architectural Collection, you have the tools that make it easier to design and build today's most popular, time-proven architectural styles.



## ANDERSEN HOME STYLE PATTERN BOOKS

---

Since ancient Roman times, architects have relied on the use of pattern books to outline the principles and formulas of architectural styles.

These early documents recorded the building patterns that were deemed to be best, and were important tools for architects of the day in their communication with other architects, as well as builders, clients, rulers and politicians.

Today, there is a renewed interest in pattern books as planners and developers look to build new communities by learning from the successes of the past. Andersen is committed to making this type of great architectural design more attainable through our products, tools and services.

The result of years of research, pattern books from the Andersen Style Library present the quintessential architectural details of the most popular American home styles, with an emphasis on window and door design options. With these books, Andersen makes it easier for architects, builders and homeowners to communicate with a common language, and to confidently design, build and live in a home of distinction.

For more information on the Andersen Style Library, visit [andersenwindows.com/stylelibrary](https://andersenwindows.com/stylelibrary).



# The Tudor Home



The first Tudor style homes appeared in the United States around 1890. Based loosely on early English building traditions that range from simple folk houses to late medieval palaces, the Tudor style is as eclectic as it is picturesque. It's this versatility, adaptability and design flexibility that makes it a style we greatly admire.

While the most distinctive feature of these homes are their exposed timbers interspersed with stucco, details are often borrowed liberally from Renaissance

or American Eclectic traditions such as Craftsman or Prairie style. The Tudor style's preference for asymmetrical design provides additional flexibility. For example, the bay and bow windows that are so common in this style may be placed on any side of the home to capture the views outside.

Although the original Tudor house style craze peaked in the 1920s and 1930s, the style remains popular in homes designed and built today – yet another testament to its beauty and time-proven adaptability.



**ESSENTIAL STYLE ELEMENTS**

- Steeply pitched roofs with single or multiple front gables
- Decorative half timbering with stucco or brick infill
- Large, elaborate chimneys
- Asymmetrical door and window compositions with bay windows
- Recessed entries, often arched
- Combinations of stucco, wood, brick and/or stone exteriors

**EXTERIOR COLOR PALETTE**

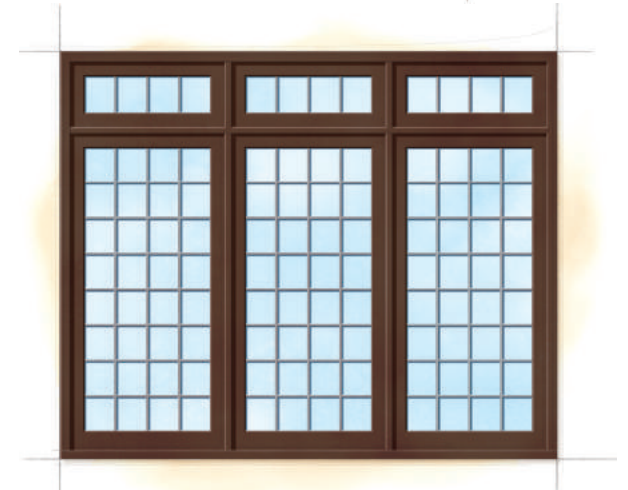
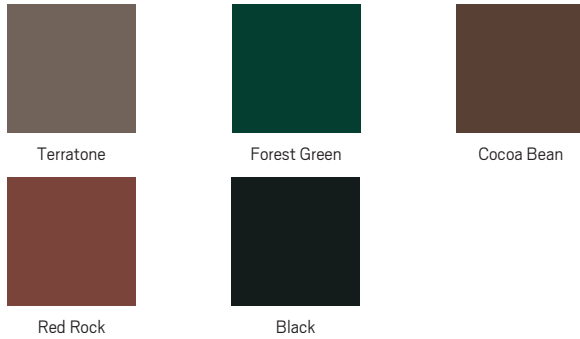

## Quintessential Windows

Although the Tudor style uses a number of window types, the most common is a casement window, often with multiple windows mullioned together. Transom windows above doors and windows are also typical, as are bay windows projecting from the first or second story.

Grilles may be diamond patterned or rectangular, and it's not unusual for both patterns to be used on the same house.



Casement exterior



Casement interior



## Quintessential Doors

While there is a range of doors that is appropriate for Tudor style homes, some themes are more prevalent than others.

For the main entry, a plank with a half-round arched top and a small panel of glass is common. A diamond grille pattern in the small glass panel greatly adds to the Old World look of a Tudor style home.

Rectangular doors are also popular. When used at the main entry, it is usually set back inside a vestibule that has an arched entrance. Main entry doors are most often oak with a medium to dark stain.

An auxiliary door that had a utilitarian function was often a plank construction type of door. For doors leading to a garden, glass panels were often used.



## Colors & Finishes

Window colors are deep, warm and dark. The window's frame, sash and trim are usually one color – typically a dark brown or a reddish-brown – and the wall material is white or beige stucco. However, the wall material does not need to contrast with the windows themselves and can be of similar color value.

### Window/Door Exterior

Color Palette



Terratone



Forest Green



Cocoa Bean



Red Rock



Black

### Exterior Trim

Color Palette



Terratone



Forest Green



Cocoa Bean



Red Rock

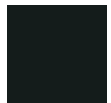

Black

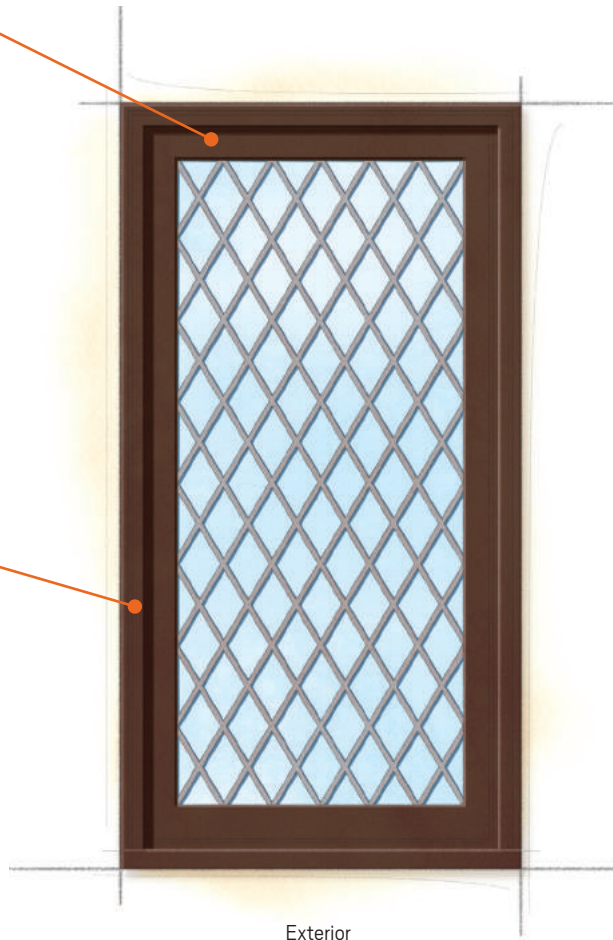

Exterior



Interior

### Window/Door Interior

Wood Species



Pine



Oak

### Window/Door Interior

Stain Colors



Honey

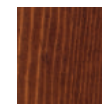











Russet

## Color Combinations

### • ANDERSEN AUTHENTICITY •

Andersen® E-Series windows make it easy to match other building materials and to complement your color palette. They're available in 50 exterior colors, plus custom colors for unlimited possibilities.

To match existing interiors, E-Series products allow you to specify virtually any wood species in a range of finishes. Or choose a custom stain for an exact match.

		EXTERIOR TRIM COLOR					
		Terratone	Forest Green	Cocoa Bean	Red Rock	Black	
WINDOW/DOOR COLOR	Terratone						
	Forest Green						
	Cocoa Bean						
	Red Rock						
	Black						

## Primary Windows

Single windows in a Tudor style home are vertical in proportion. While tall, slender casement windows are standard, double-hung windows that are slightly wider than the casement windows are also sometimes used. Accent windows can be nearly square if desired.

Since Tudor homes are an eclectic mix of historic styles, grille pattern proportions can vary as much as 20 percent from one window to the next.

### • ANDERSEN AUTHENTICITY •

Andersen® Architectural Collection windows are available in custom sizes. Both the primary windows shown here and the accent windows on the next page can be ordered to the specifications your Tudor style home requires.

### QUINTESENTIAL PRIMARY WINDOW WITH TRIM

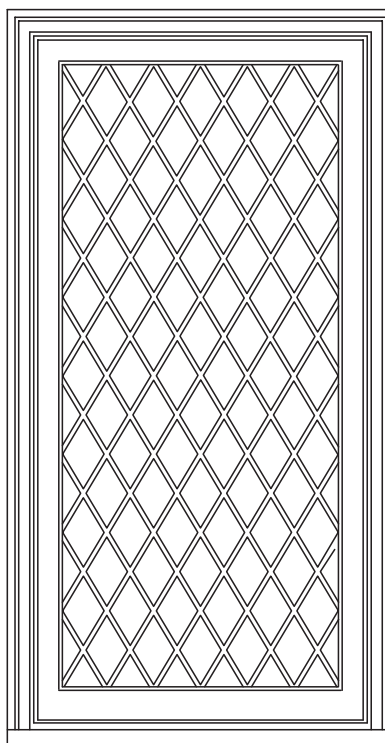

### Typical Proportion Ratios

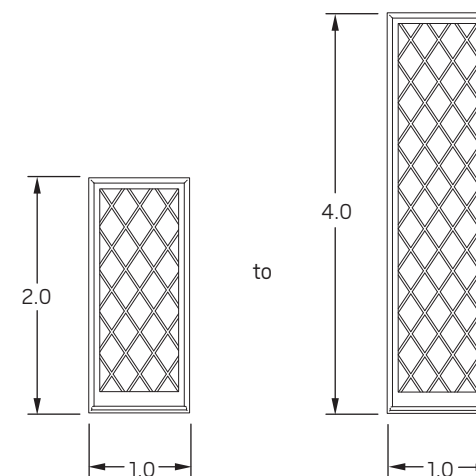

## Accent Windows

For accent windows, casement windows are preferable and double-hung windows are rarely used.

Small, narrow accent windows are commonly used in powder rooms, hallways and near entranceways. Slightly wider accent windows are used for dormers and gables. These may be single windows or windows grouped in combination.

### QUINTESENTIAL ACCENT WINDOWS

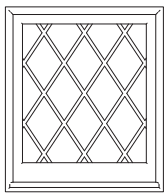

Small casement window

With Trim

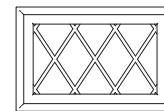
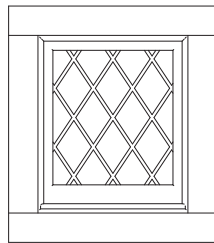

Transom window commonly used over casement windows

With Trim

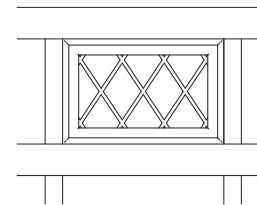

## Window Groupings

A group of three equally sized casement windows or double-hung windows mullled together is the most common combination. However, the number of combined windows can be as few as two or as many as five.

Casement window groupings are often mullled with transom windows of equal width, with both window types having the same grille pattern.

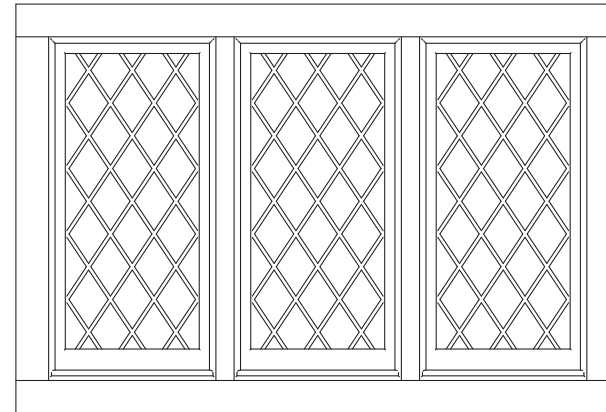

3-wide casement window grouping

### • ANDERSEN AUTHENTICITY •

Every A-Series product from the Andersen® Architectural Collection features common design elements to make creating authentic window groupings easier.

With A-Series products, you can specify different window types and still have their sash design, grille profiles, glass setback, sight lines and frame depth match and align perfectly.

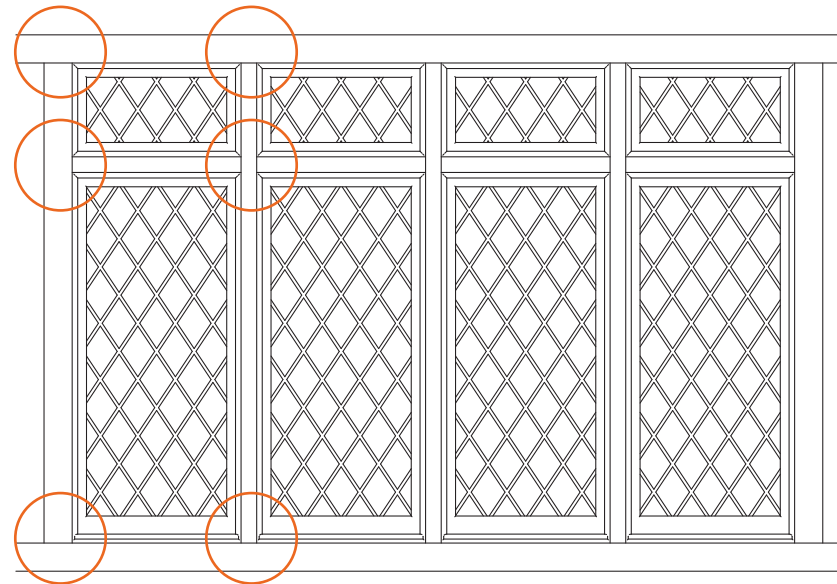

4-wide casement window grouping with transoms.

Trim is integral with half timber house trim.

Circled areas – See Typical Trim Conditions details on page 13.

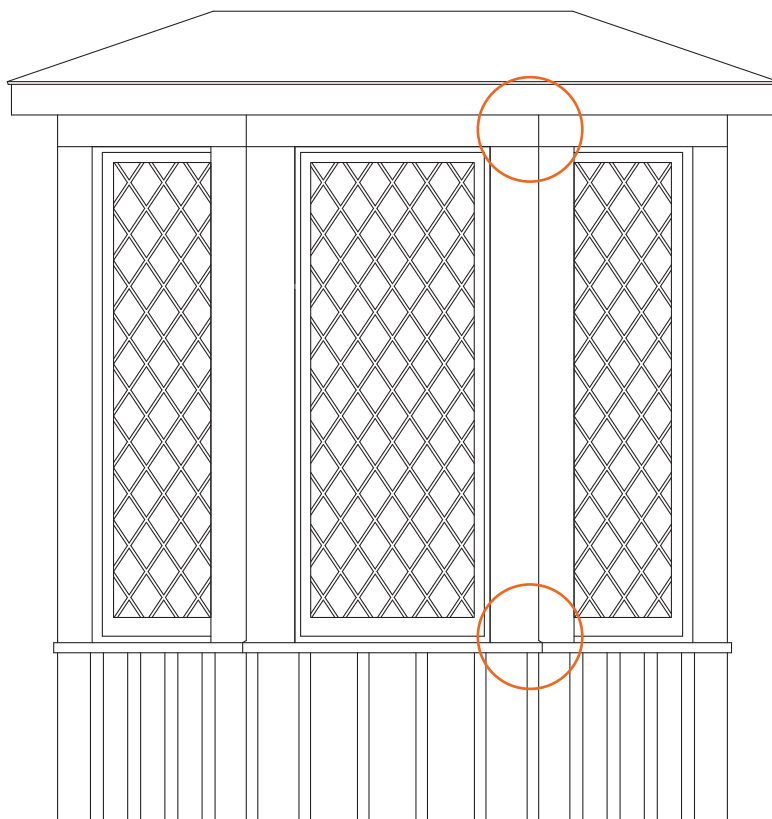

Angled bay window with casement windows.  
Circled areas – See Typical Trim Conditions details.

**TYPICAL TRIM CONDITIONS**

For an authentic appearance, double-hung windows should utilize a wide mullion spacing. Inversely, casement windows are most authentic with a narrower mullion spacing, preferably 4" or less.

	Jamb	Vertical Mullion	Corner
Head			
Horizontal Mullion			N/A
Sill			
Horizontal Section			
Vertical Section			

## Sash & Grille Design

Tudor style windows offer rich character that greatly contributes to the overall look of the home.

The sash thickness is traditionally  $1\frac{3}{8}$ " with a deep glass setback placed near the middle of that measurement. Additionally, grille and sash profiles are alike on the interior and the exterior respectively.

For double-hung windows, the top rail of the sash should be the same width as the stiles. Also, the bottom rail should be wider than the stiles and the top rail.

### • ANDERSEN AUTHENTICITY •

Andersen® A-Series windows were designed in conjunction with leading architects. As such, double-hung, casement and picture windows feature these sash and grille details for architectural authenticity:

- Bottom rail of the sash is wider than the stiles and top rail
- A deep glass setback for historical accuracy
- Grille profile faces are flush with the sash face to simulate traditional wood muntins
- Exterior grille profiles accurately simulate the look of putty glazing on a historic window
- Diamond pattern art glass with metal caming and dual-pane insulated glass available for a historically authentic appearance

Andersen products allow you to specify custom grille patterns, making it easy to create an exact match in historical applications.

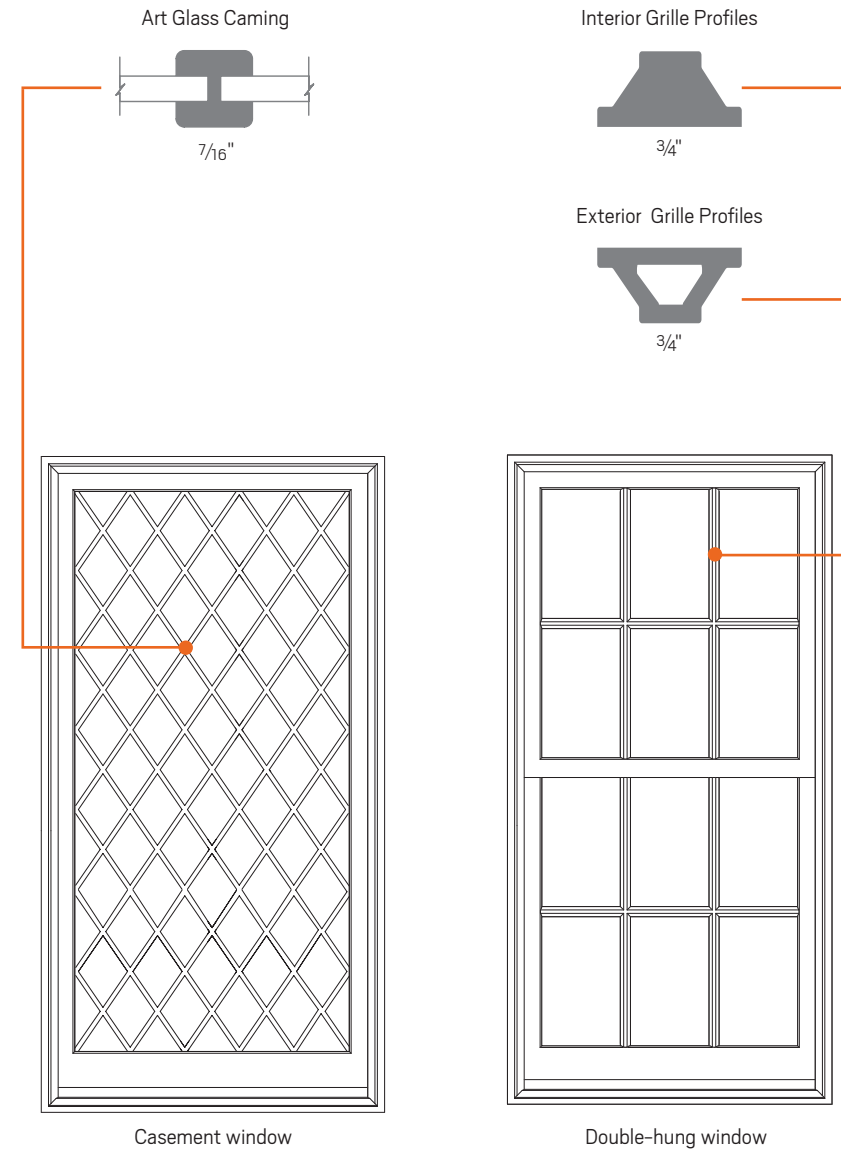



## Grille Patterns

Diamond patterns with metal caming are the traditional choice for Tudor style casement windows, although square patterns are occasionally selected. For double-hung windows, rectangular patterns are preferred and may be made of wood. A combination of diamond patterns and rectangular patterns may be used in the same house.

When using diamond patterns, grilles that go directly into the corners as shown on page 14 are ideal. An alternative is to shift the grille pattern vertically by half the height of a single pane or horizontally by half the width of a single pane.



Andersen® double-hung windows. Colonial grille pattern.

### ALTERNATIVE CASEMENT AND AWNING WINDOW GRILLE PATTERNS

Primary Windows



Rectangular grilles



Art glass with metal caming

Accent Windows



Rectangular grilles



Art glass with metal caming

### ALTERNATIVE PICTURE WINDOW GRILLE PATTERNS

Primary Windows



Rectangular grilles



Art glass with metal caming

Accent Windows



Rectangular grilles



Art glass with metal caming

### ALTERNATIVE TRANSOM WINDOW GRILLE PATTERNS

Primary Windows

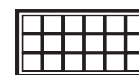

Rectangular grilles

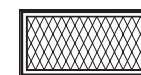

Art glass with metal caming

## Door Proportions

The main entry door is typically as wide as or wider than any other single exterior door in the home. However, for a patio door that has multiple doors, or for a door with sidelights, the overall unit size is wider than that of the main entry door.

### TYPICAL PROPORTION RATIOS – MAIN DOORS

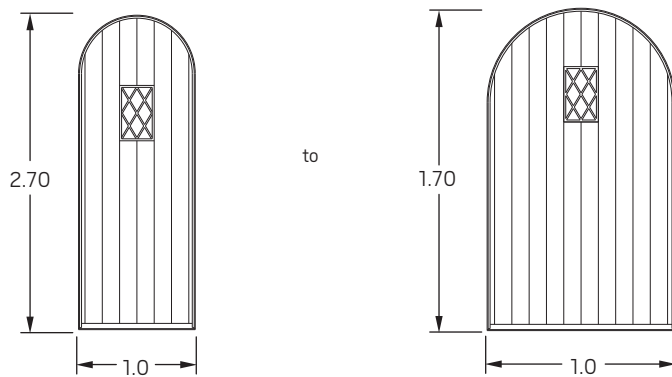

### TYPICAL PROPORTION RATIOS – AUXILIARY DOORS

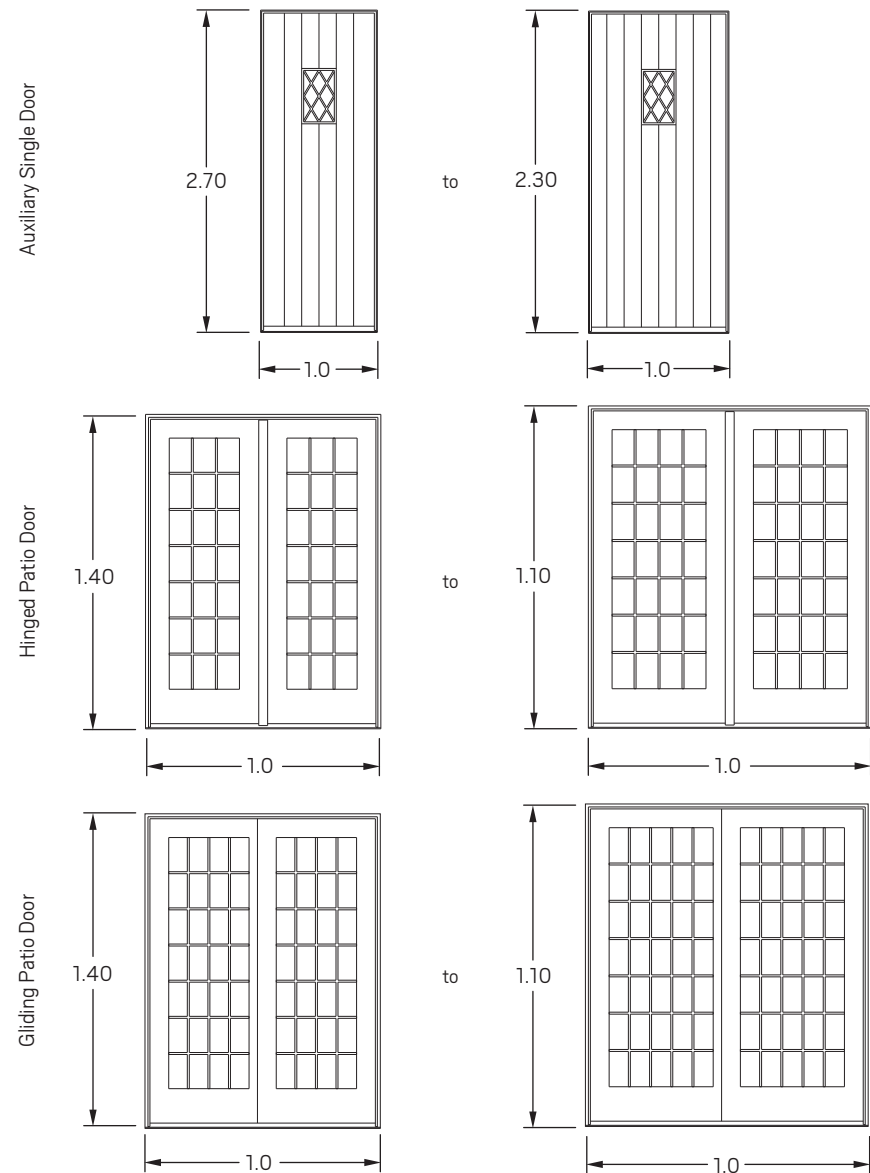

## Main Entries with Trim

The following two main entry types are commonly found in Tudor homes:

### Type A:

- No covered porch
- Door is near the surface of the building
- Door shapes are either half-round archtopy or Tudor archtopy
- A narrow window placed 1–2 feet from the entry door

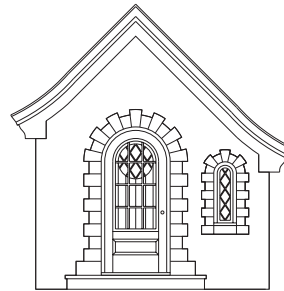

Type A main entry



Type B main entry



Main entry door  
(out of context)

### Type B:

- Exterior, unheated, covered porch
- Half-round arch or Tudor arch opening to porch
- Door is set back inside the entry porch
- Door shapes include half-round archtopy, Tudor archtopy and rectangular flattopy
- No small window near door

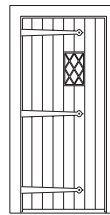

Quintessential  
side door

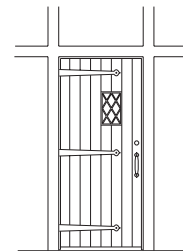

Side door with  
half-timbering trim

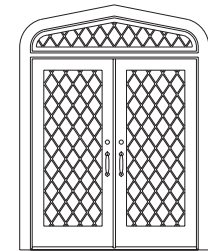

Standard hinged patio  
doors with custom  
Tudor transom window

## Auxiliary Entries with Trim

Side doors are typically rectangular and have a small glass area with diamond grilles in the upper portion. For rooms where more natural light is desired or to visually connect indoor and outdoor spaces, hinged patio doors are ideal, although gliding patio doors are also alternatives. While doors featuring large expanses of glass historically had rectangular grille patterns, diamond-patterned grilles are also appropriate.

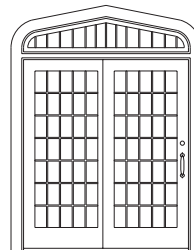

Standard gliding patio  
door with custom Tudor  
transom window

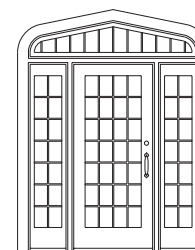

Standard patio door &  
sidelights and custom  
Tudor transom window

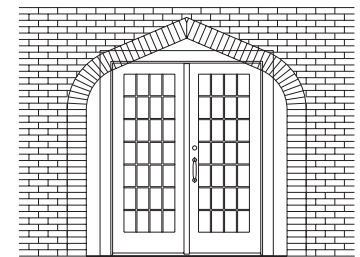

Rectangular patio door set  
back inside shallow  
Tudor arched opening

## Window Hardware

Tudor window hardware is simple and functional. Integral hardware elements include sash lifts and locks. A distressed bronze finish is most authentic for the style.

### DOUBLE-HUNG HARDWARE



### CASEMENT HARDWARE



Folding handle shown in Distressed Bronze.

### WINDOW HARDWARE FINISH OPTIONS

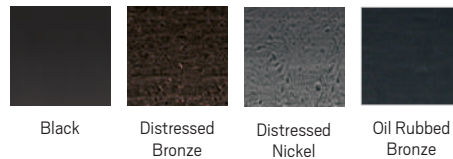

Printing limitations prevent exact finish replication. Please see your Andersen supplier for actual finish samples. Distressed Bronze and Oil Rubbed Bronze are "living" finishes that will change with time and use.

## Door Hardware

Hardware for a Tudor style door commonly features a thumb latch, long strap iron hinges and a door knocker. A distressed bronze finish is most popular.

### • ANDERSEN AUTHENTICITY •

Andersen® Yuma® hardware is an ideal complement for Tudor style homes. Made of solid, forged brass for a substantial Tudor style look and feel, it features a simple, clean design and is available in a deep, distressed bronze finish that is historically accurate. As an alternative, a distressed nickel finish is also available.

## DOOR HARDWARE

Gliding



Hinged



**ENCINO®**

Distressed Bronze

Gliding



Hinged



**YUMA®**

Distressed Nickel

## DOOR HARDWARE FINISH OPTIONS

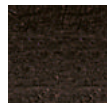

Distressed  
Bronze



Distressed  
Nickel

Printing limitations prevent exact finish replication. Please see your Andersen supplier for actual finish samples. Distressed Bronze is a "living" finish that will change with time and use.

## Exterior Trim Style Elements

Historically, load-bearing timbers in the Tudor style home also doubled as trim elements for its windows. In what was known as half-timber construction, load-bearing timbers were visible from the street and had infill panels consisting of wattle and daub, bricks or plaster. Single windows or window groups typically fit into the areas between the timbers.

Whether the windows were set between timbers or into a masonry wall, the windows often appeared to have a chunky appearance – a look that can be simulated in today's Tudor style homes by using brick mould exterior trim.



### ALTERNATIVE EXTERIOR TRIM STYLE

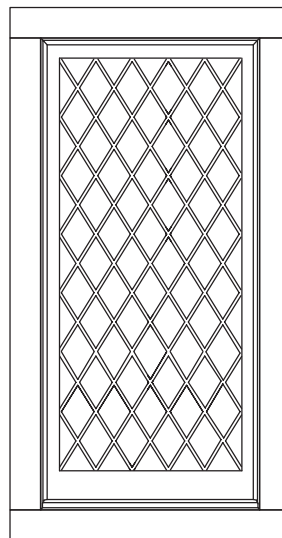

Flat casing on all sides.

### • ANDERSEN AUTHENTICITY •

For authentic Tudor style, or to create a variance all your own, A-Series products provide a choice of three exterior trim profiles and three head trim options. A-Series exterior trim is available in 11 colors, so you can match or complement your window and door colors to create a variety of looks.

You can also design your own custom trim profiles with E-Series products, plus match or contrast the trim of the windows and doors with any of 50 exterior colors, custom colors and anodized finishes.

To learn more about Andersen® trim options, visit [andersenwindows.com/exteriortrim](https://www.andersenwindows.com/exteriortrim).

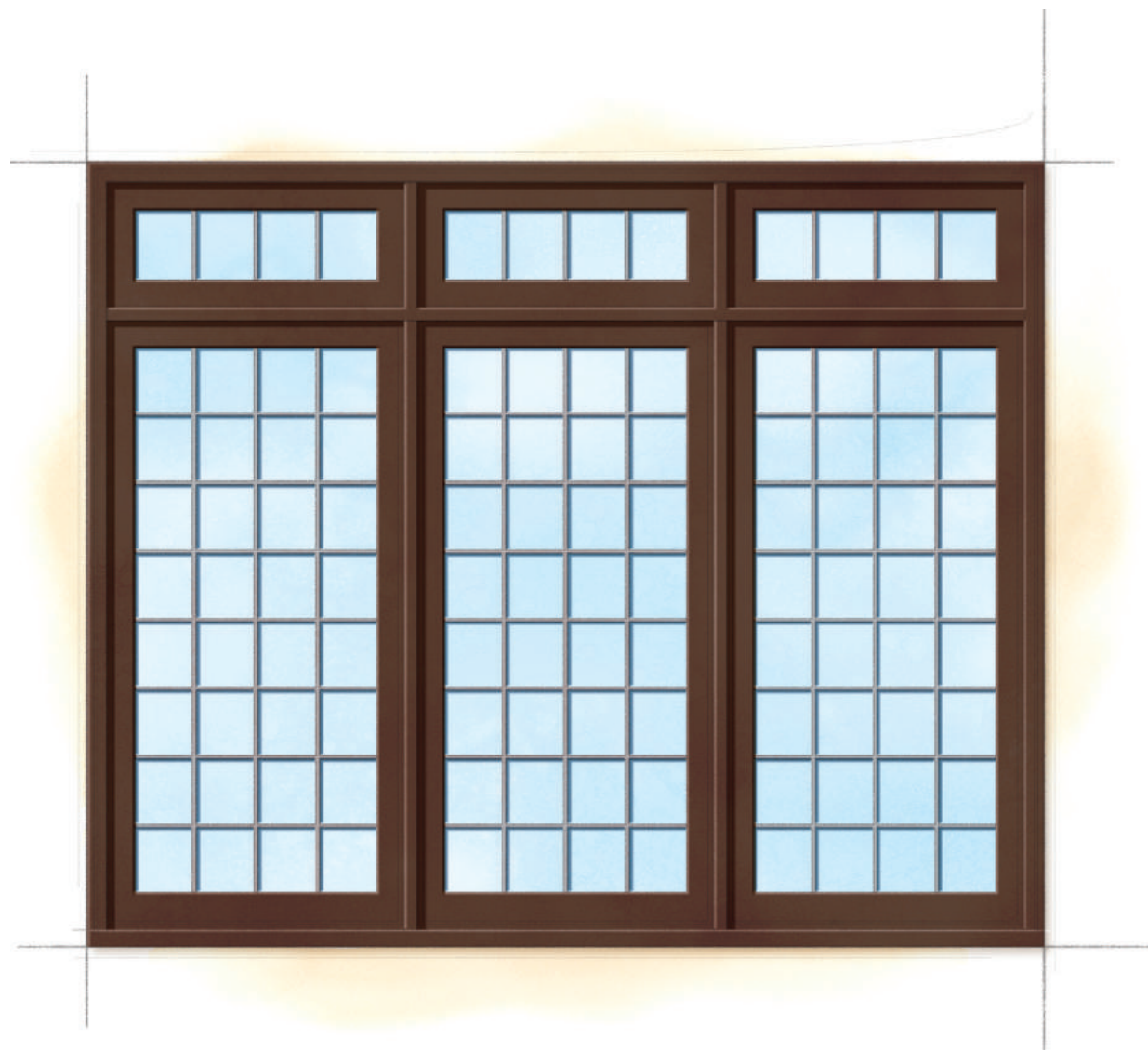

## Interior Trim Style Elements

Interior trim consists of flat casing, often including modest classical detailing. Occasionally, backband may be used.



## ALTERNATIVE INTERIOR TRIM STYLES

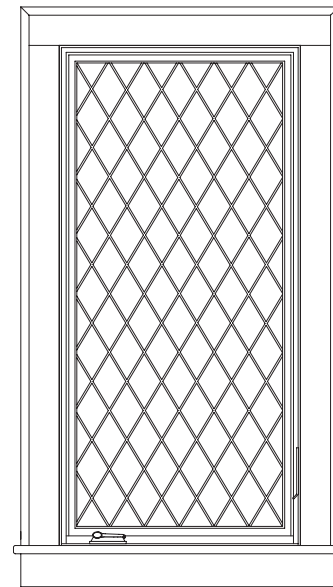

Flat casing with backband.  
Stool with eased edges and  
apron made from flat casing.

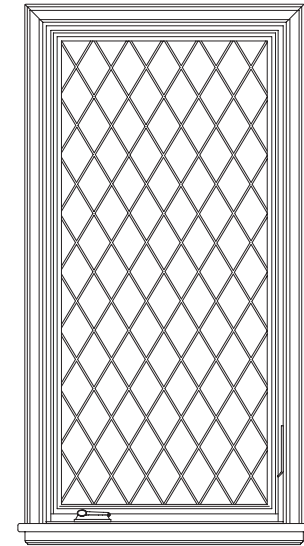

Single trim surround on head and  
jambs from narrow flat casing with  
backband. Stool with eased edges  
and apron made from flat casing.



ALTERNATIVE GROUPING AND INTERIOR TRIM STYLES

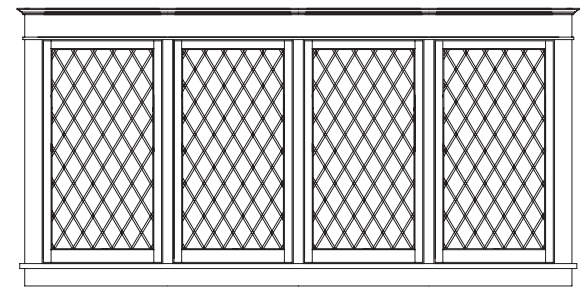

Groupings shown with narrow mull spacing

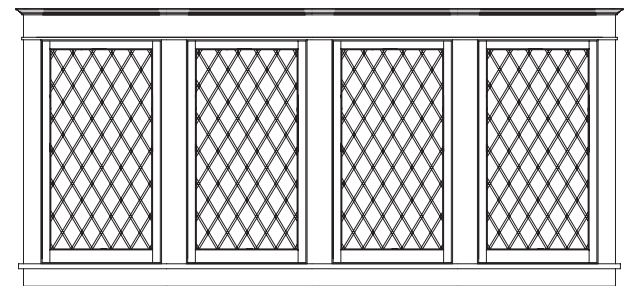

Groupings shown with wide mull spacing

## Window, Door & Trim Proportionality

Choosing the right combination of interior trim profiles and size requires careful consideration of everything from house style and room dimensions to furnishings and room function.

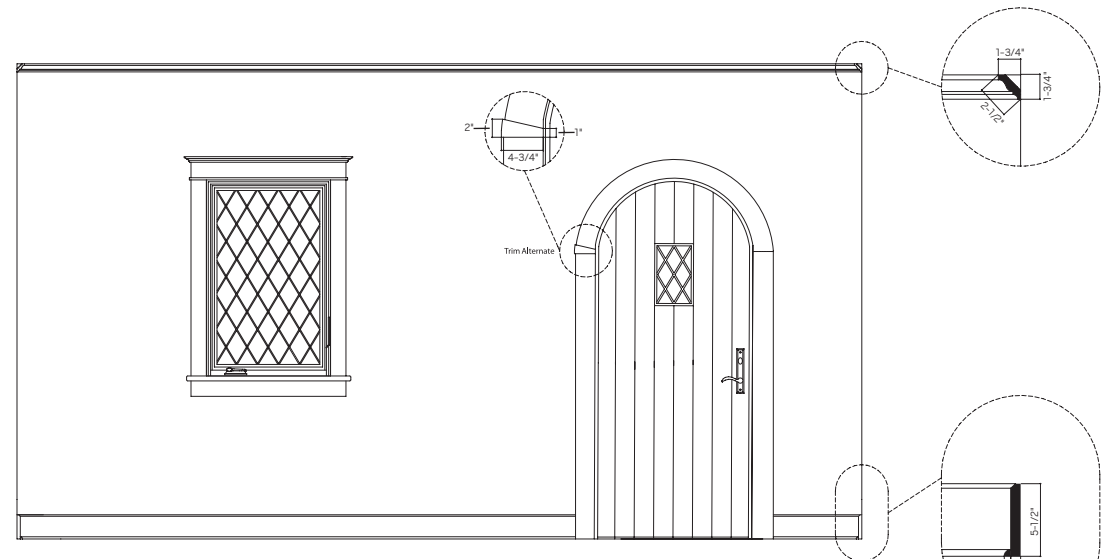

### Quintessential Interior Room Trim 1

Tudor room ensemble featuring common plank door in half-round archtop shape. Simple baseboard with base shoe. Modest ogee and cove-shaped crown moulding at ceiling.

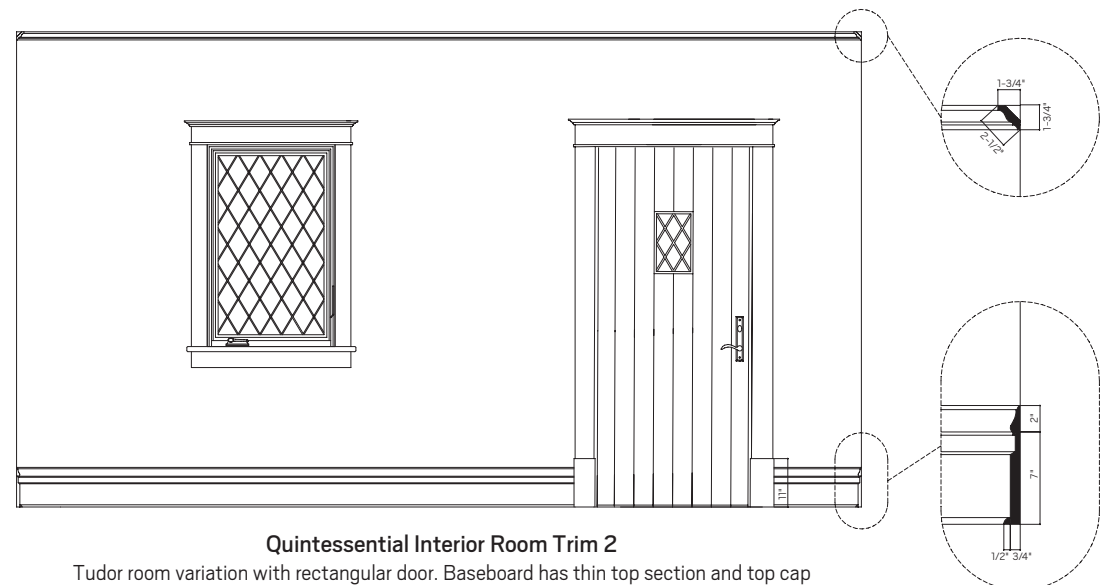

### Quintessential Interior Room Trim 2

Tudor room variation with rectangular door. Baseboard has thin top section and top cap creating bold shadow line. Modest ogee and cove-shaped crown moulding at ceiling. Plinth blocks anchor the door casing and serve to terminate the more elaborate baseboard trim.

## Tudor Andersen® Product Index



**Casement window (exterior)**

- 2" brick mould exterior trim: Cocoa Bean
- Frame exterior: Cocoa Bean
- Sash exterior: Cocoa Bean
- Diamond pattern art glass

Shown on pages 5, 6, 8 and 20.

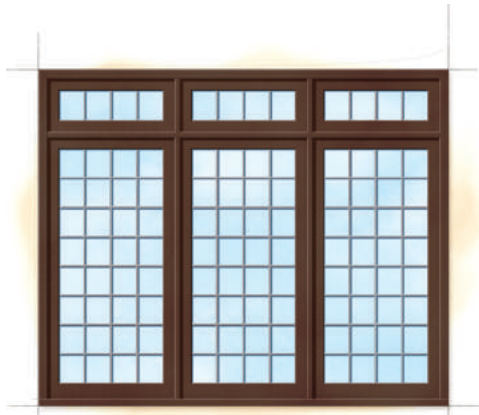

**Casement and transom window combination (exterior)**

- 2" brick mould exterior trim: Cocoa Bean
- Frame exterior: Cocoa Bean
- Sash exterior: Cocoa Bean
- Specified equal light grille pattern

Shown on pages 5 and 21.



**Hinged inswing patio door (exterior)**

- 2" brick mould exterior trim: Cocoa Bean
- Frame exterior: Cocoa Bean
- Panel exterior: Cocoa Bean
- Specified equal light grille pattern
- Yuma® door hardware: Distressed Bronze

Shown on pages 5 and 7.



**Casement window (interior)**

- Frame interior: Oak with Russet finish
- Sash interior: Oak with Russet finish
- Diamond pattern art glass
- Traditional casement window folding handle: Distressed Bronze

Shown on pages 6, 8 and 22.



**Casement and transom window combination (interior)**

- Frame interior: Oak with Russet finish
- Sash interior: Oak with Russet finish
- Specified equal light grille pattern
- Traditional casement window folding handle: Distressed Bronze

Shown on page 23.



**Straightline curved glass panel single door (203) with sidelights (101) (exterior)**

- 2" brick mould exterior trim: Cocoa Bean
- Panel exterior: Oak with Russet finish
- Specified equal light grille pattern
- Yuma door hardware: Distressed Bronze

Shown on page 7.



"Andersen" and all other marks where denoted are trademarks of Andersen Corporation.  
©2018 Andersen Corporation. All rights reserved. 12/18 Part #9070657