



HOME STYLE PATTERN BOOK

Queen Anne

A Victorian Selection from the Andersen Style Library

HOME STYLE PATTERN BOOK
Queen Anne

A Victorian Selection from the Andersen Style Library

Queen Anne Home Style Overview.....4
Quintessential Windows & Doors6
Colors & Finishes.....8
Primary Windows 10
Accent Windows 11
Window Groupings..... 12
Sash & Grille Design..... 14
Grille Patterns..... 15
Door Proportions..... 16
Entries with Trim 17
Window & Door Hardware 18
Exterior Trim Style Elements.....20
Interior Trim Style Elements 22
Interior Room Trim Example24
Art Glass Style & Location25
Product Index 26



THE ANDERSEN® ARCHITECTURAL COLLECTION

The Architectural Collection is an industry-leading, innovative approach to windows and doors that's based not on the type of window or door, but rather on the style of home you want to create.

Consisting of Andersen® A-Series and E-Series products, the collection offers two approaches to attaining authentic architectural style.

A-Series products were designed in conjunction with leading architects. These windows and doors feature a unique system of options that work seamlessly together, allowing you to produce virtually any style with ease.

E-Series windows and doors are made to your exact specifications and give you unmatched design freedom within the architectural style you've chosen. They allow you to create dramatic shapes and sizes, and feature 50 standard colors, custom colors, plus a wide range of interior wood species.

With the Architectural Collection, you have the tools that make it easier to design and build today's most popular, time-proven architectural styles.



ANDERSEN HOME STYLE PATTERN BOOKS

Since ancient Roman times, architects have relied on the use of pattern books to outline the principles and formulas of architectural styles.

These early documents recorded the building patterns that were deemed to be best, and were important tools for architects of the day in their communication with other architects, as well as builders, clients, rulers and politicians.

Today, there is a renewed interest in pattern books as planners and developers look to build new communities by learning from the successes of the past. Andersen is committed to making this type of great architectural design more attainable through our products, tools and services.

The result of years of research, pattern books from the Andersen Style Library present the quintessential architectural details of the most popular American home styles, with an emphasis on window and door design options. With these books, Andersen makes it easier for architects, builders and homeowners to communicate with a common language, and to confidently design, build and live in a home of distinction.

For more information on the Andersen Style Library, visit andersenwindows.com/stylelibrary.



The Queen Anne Home



From 1880 to 1910, the Queen Anne style so completely dominated Victorian residential architecture that it has become synonymous with the word “Victorian” for many people.

Queen Anne architecture displayed a taste for all things current and fashionable. This desire led people to embrace the possibilities of mass production that made design elements more affordable and more obtainable. As such, the wall surfaces in Queen Anne style homes became primary

decorative elements by incorporating gables, bay windows, towers, overhangs, wall projections, trim and multiple cladding materials of various textures.

The result is an exuberant collection of eclectic details combined in delightful and unexpected ways. It's this predictable unpredictability that makes it one of our favorite styles at Andersen, as well as an ideal candidate for the products of our Architectural Collection and its many flexible design components.



ESSENTIAL STYLE ELEMENTS

- Textured surfaces, decorative patterns of wood or stone, various colors of shingles and slate
- Elaborate decorative trim, stained glass and an array of colors – every surface adorned
- Towers, turrets, porches, balconies and bay windows
- Two, three or more stories, with cantilevered upper stories
- Intersecting hip, gable and conical roofs
- Asymmetrical massing

EXTERIOR COLOR PALETTE

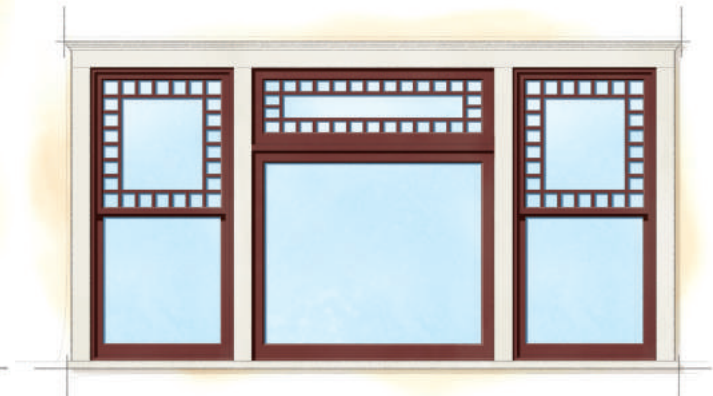

Quintessential Windows

Like most homes in the Victorian style, Queen Anne style houses have tall, double-hung windows. One way Queen Anne homes differ from Victorian, however, is that double-hung windows in the Queen Anne style are far more likely to have the upper sash decorated with art glass or with a decorative grille pattern combined with colored glass.

Windows in Queen Anne style homes are often paired or tripled and feature trim that ranges from simple backband and cornices to elaborately carved pediments.

Bay windows are common and occasionally have unequal sash – primarily on the first floor where the windows might be quite tall. Additionally, cottage style windows, which have an upper sash that is smaller than the lower sash, are popular on the main floor at the front of the house.

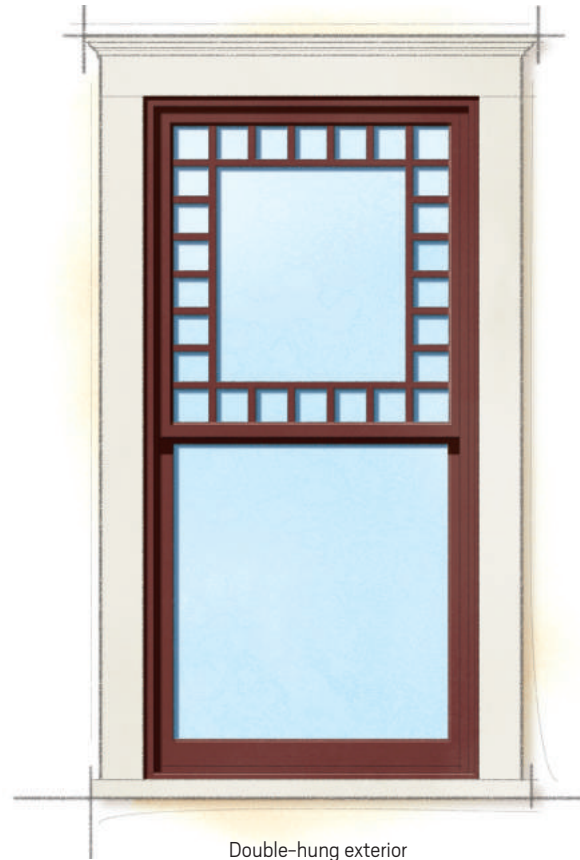

Double-hung exterior

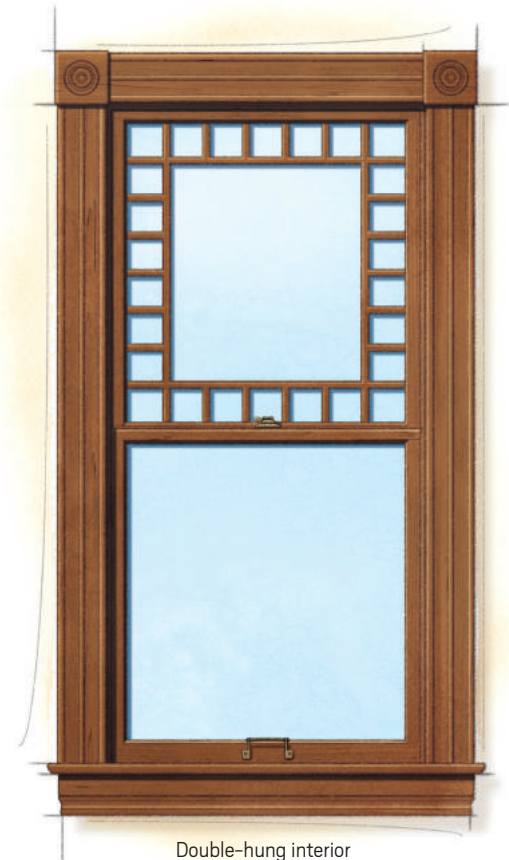

Double-hung interior

Quintessential Doors

Main entry doors feature a variety of styles in both single or double door units. The doors are simple, rectangular, raised-panel doors and often have mail slots. Typically, transom windows with art glass are used above the doors. Frequently, the upper half of the doors also includes art glass. Sidelights are not common.

Side doors, back doors and other auxiliary doors are less elaborate than main doors, but often have art glass and transom windows. Patio doors were not used on period Queen Anne homes, but these doors can easily be styled to work well and suit the needs of today's homeowners.

Exterior doors are commonly painted, although hardwood doors are occasionally stained a dark color.



Main entry door exterior

Auxiliary patio door exterior

Colors & Finishes

The Victorians painted their houses in a rainbow of colors. Although brighter colors are standard for Queen Anne homes today, the Victorian preference was for darker earth-tone colors, including but not limited to sienna, red, forest green, burnt yellow and muddy brown.

Window/Door Exterior Color Palette



Exterior Trim Color Palette

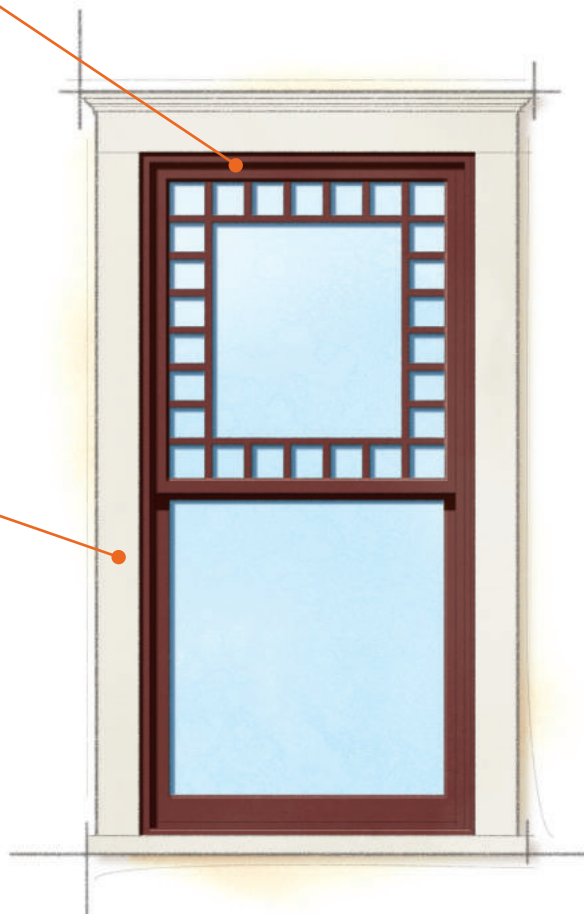

Exterior

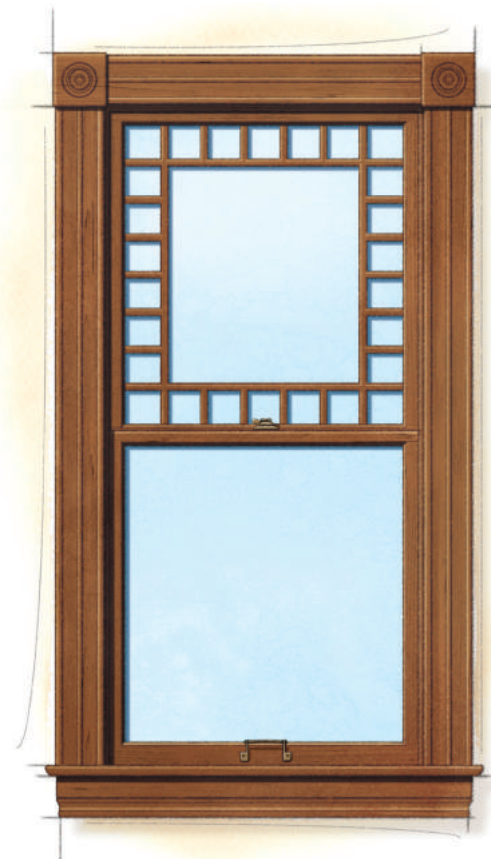

Interior

Window/Door Interior Wood Species

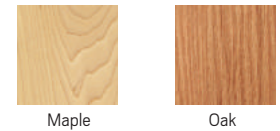

Window/Door Interior Stain Colors

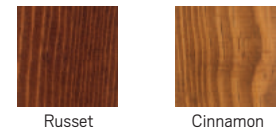

Window/Door Interior Painted

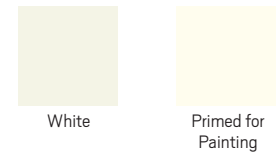

Color Combinations

		EXTERIOR TRIM COLOR							
		White	Canvas	Prairie Grass	Forest Green	Dove Gray	Cocoa Bean	Red Rock	Black
WINDOW/DOOR COLOR	White								
	Canvas								
	Forest Green								
	Dove Gray								
	Cocoa Bean								

• ANDERSEN AUTHENTICITY •

Andersen® E-Series windows make it easy to match other building materials and to complement your color palette. They're available in 50 exterior colors, plus custom colors for unlimited possibilities.

To match existing interiors, E-Series products allow you to specify virtually any wood species in a range of finishes. Or choose a custom stain for an exact match.

Primary Windows

Victorian style homes, including Queen Anne, are known for their grand and imposing vertically shaped windows. Tall, narrow double-hung windows are most common, and should be at least 2½ times taller than they are wide.

Cottage style windows, typically used in the front of the house, are usually quite large and feature art glass or grilles either in the upper sash or in a transom window above them. This combination of cottage window and transom window can be simulated with a picture window that includes a wide, horizontal grille near the top. However, a picture window with a transom window is most authentic. For illustrations of cottage style windows, see page 13.

• ANDERSEN AUTHENTICITY •

Andersen® Architectural Collection windows are available in custom sizes. Both the primary windows shown here and the accent windows on the next page can be ordered to the specifications your Queen Anne style home design requires.

QUINTESSENTIAL PRIMARY WINDOW WITH TRIM

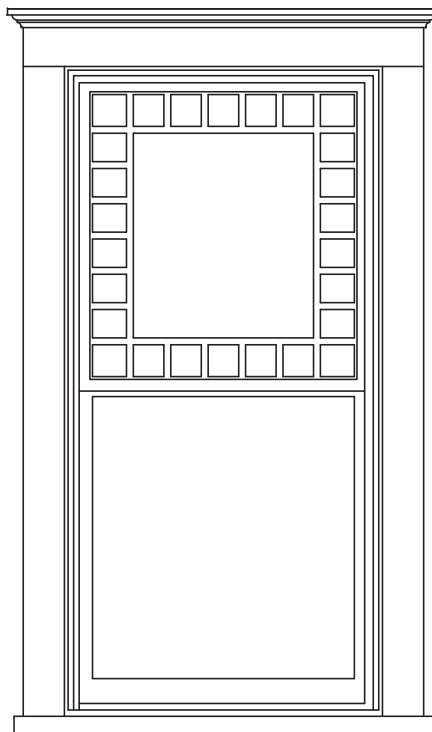

Typical Proportion Ratios

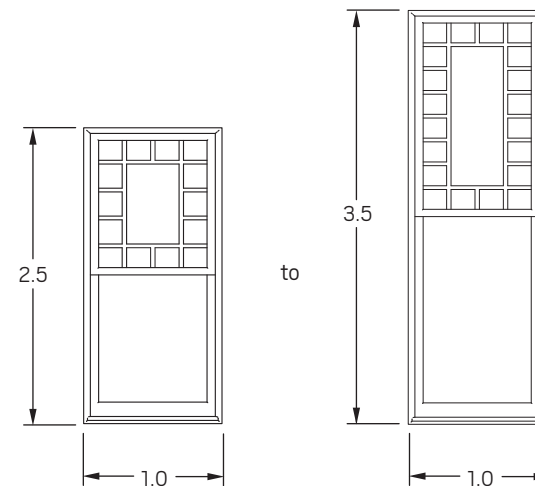

Accent Windows

Towers and gable ends are popular places for accent windows in Queen Anne style homes. Fanciful shapes such as circles, diamonds and gothic arches are common, and are sometimes operable. Although casement windows are not historically accurate, they're acceptable today in Queen Anne style architecture as accent windows – particularly where ventilation is desired.

• ANDERSEN AUTHENTICITY •

To create historically authentic accent windows, Andersen® A-Series and E-Series windows are available with custom grilles. Whether it's the quintessential specialty swag shown here, a variation or something of your own design, we'll work with you to create the look you want. For details, see your Andersen supplier.

QUINTESSENTIAL ACCENT WINDOWS

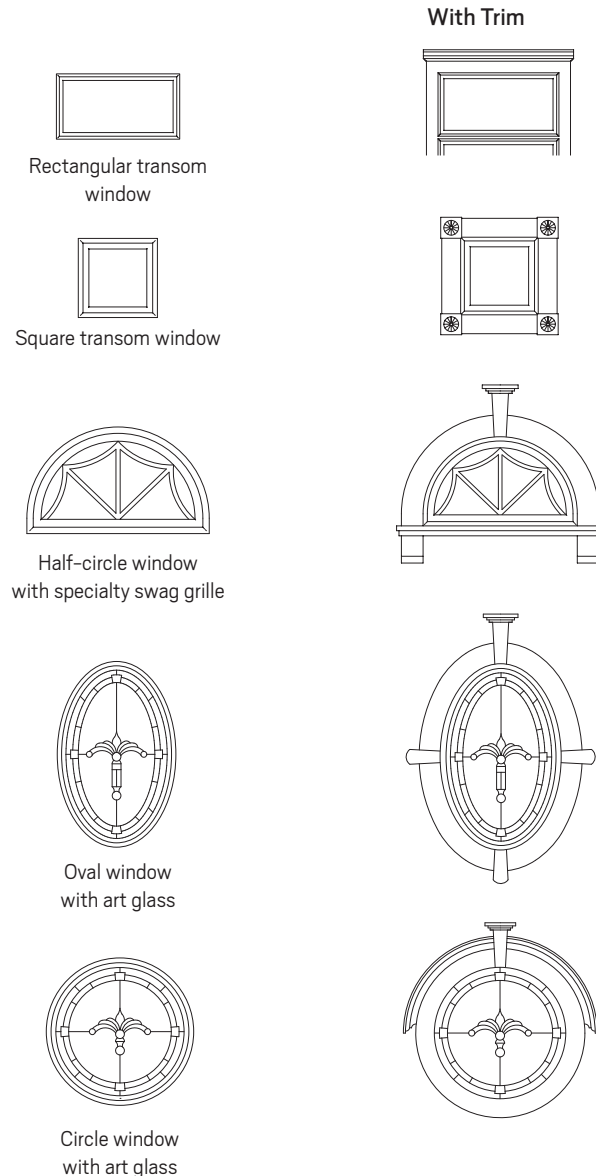

Window Groupings

Windows may be single openings, mulled together in pairs or multiple window types mulled together in bay windows. Transom windows, often with art glass, are only used when mulled over doors or over front picture windows.

• ANDERSEN AUTHENTICITY •

Every A-Series product from the Andersen® Architectural Collection features common design elements to make creating authentic window groupings easier.

With A-Series products, you can specify different window types, like those shown in the angled bay grouping, and still have their sash design, grille profiles, glass setback, sight lines and frame depth match and align perfectly.

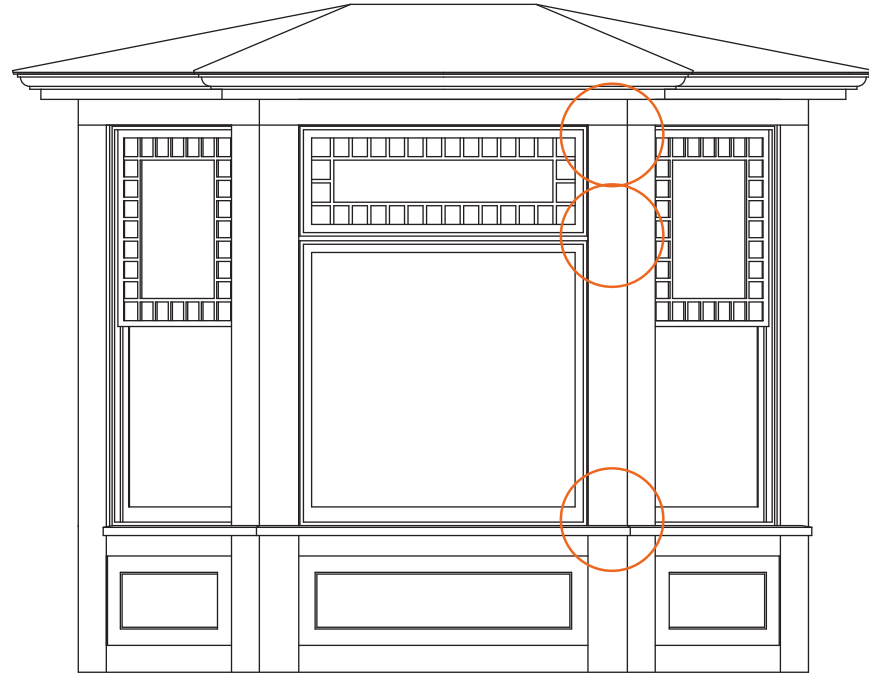

Angled bay grouping showing a Cottage Front Type 2 window grouping with flanking double-hung windows in angled walls. Queen Anne grilles are shown. Circled areas – See Typical Trim Conditions details on page 13.

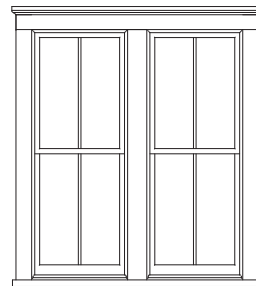

Two-wide double-hung grouping.
+/- 5 1/2" mull is a very authentic size.

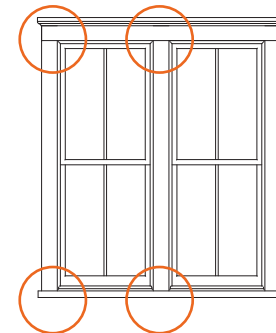

Alternate two-wide double-hung grouping.
Jamb and mullion trim widths must match and be approximately 4 1/2" wide for central rosette to fit. Circled areas – See Typical Trim Conditions details on page 13.

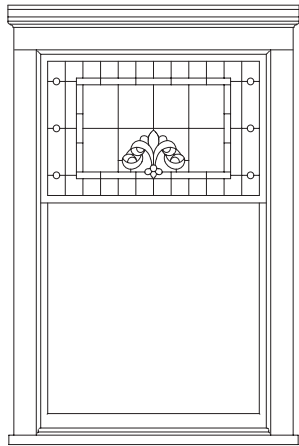

Type 1
Cottage Front Window
 Cottage style double-hung window.
 Often with art glass in upper sash.

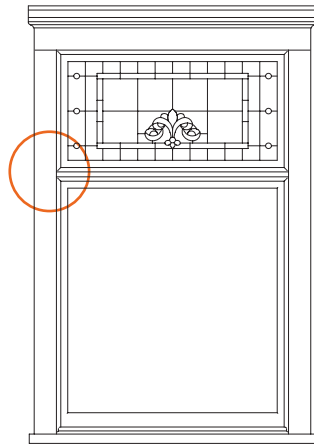

Type 2
Cottage Front Window
 Picture window with transom window.
 Art glass is common in transom windows. Circled areas – See Typical Trim Conditions details.

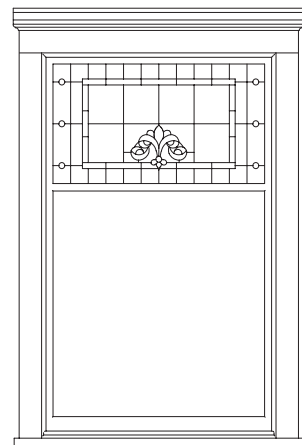

Type 3
Cottage Front Window
 Picture window with wide horizontal grille (simulated check rail).
 Often with art glass in upper sash.

TYPICAL TRIM CONDITIONS

Standard Queen Anne windows are almost always double-hung windows. To simulate the weight pockets of double-hung windows from the late 1800s and early 1900s, wide mullion spacing is preferred. For a more ornate appearance, corbels, rosettes and aprons may be used.

	Jamb	Vertical Mullion	Corner
Head			
Horizontal Mullion		N/A	
Sill			
Horizontal Section			
Vertical Section			

Sash & Grille Design

Queen Anne style windows offer rich character that greatly contributes to the overall look of the home.

The sash thickness is traditionally $1\frac{3}{8}$ " with a deep glass setback placed near the middle of that measurement. Additionally, grille and sash profiles are alike on the interior and the exterior respectively.

For double-hung windows, the top rail of the sash should be the same width as the stiles. Also, the bottom rail should be wider than the stiles and the top rail.

• ANDERSEN AUTHENTICITY •

Andersen® A-Series windows were designed in conjunction with leading architects. As such, double-hung, casement and picture windows feature these sash and grille details for architectural authenticity:

- Bottom rail of the sash is wider than the stiles and top rail
- A deep glass setback for historical accuracy
- Grille profile faces are flush with the sash face to simulate traditional wood muntins
- Exterior grille profiles accurately simulate the look of putty glazing on a historic window

Andersen products allow you to specify custom grille patterns, making it easy to create an exact match in historical applications.

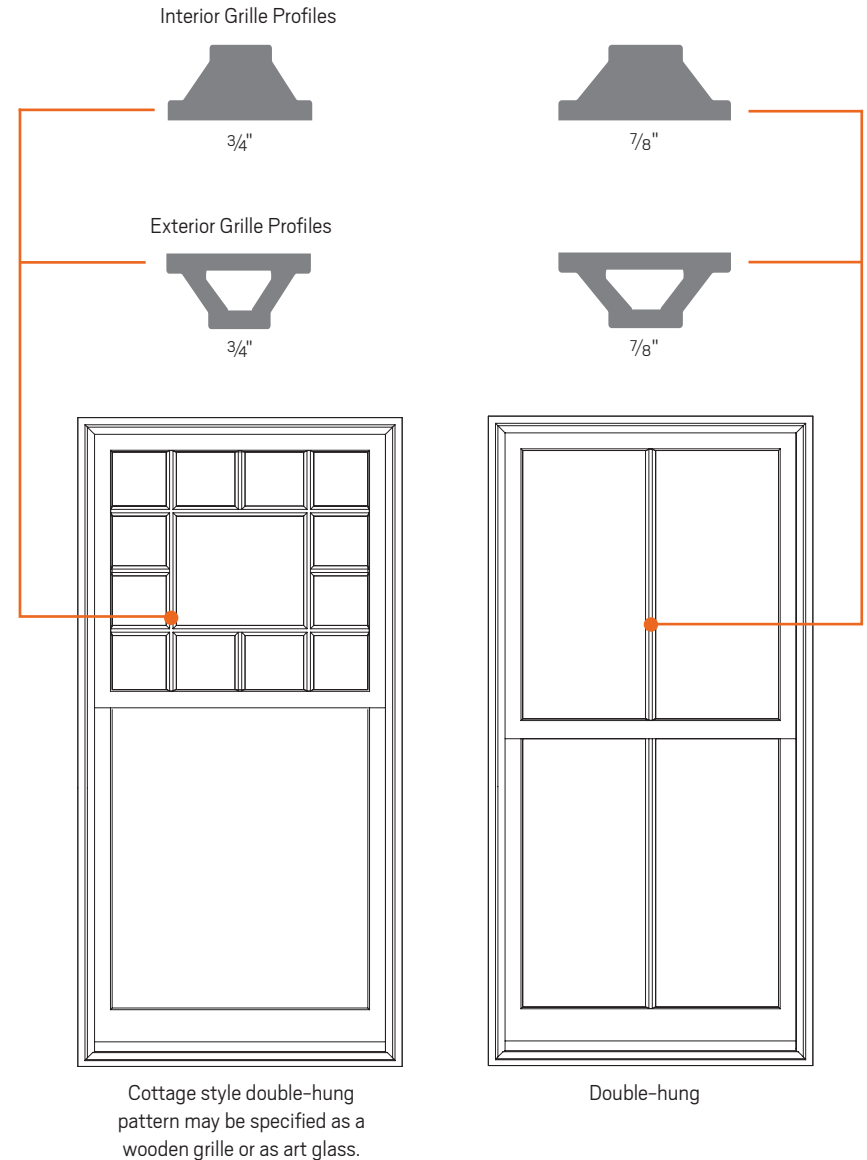

Grille Patterns

The quintessential grille pattern for a Queen Anne style window has small sections of clear or colored glass that form a pattern around the outer edge of the sash. In double-hung windows, the grilles are used only in the top sash.

The grille placement should produce glass sections that are as close to square as possible. Glass sections measuring roughly 4" are ideal. Any number of other glass sections may exist around the perimeter of the window. When the glass sections around the perimeter cannot be perfectly square, use the following rules of thumb for sizing:

- Glass sections at the top and bottom of the window should be within 12 percent of square and horizontally oriented
- Glass sections on each side of the window should be within 12 percent of square and vertically oriented

A common variant to the quintessential grille pattern uses square sections in the corners and a variety of glass section sizes around the window's perimeter. The sizes of these perimeter sections are larger than the square corner sections.

Another modified version of the quintessential grille pattern is achieved by removing the bottom row of glass sections. This is especially suitable for transom windows 20" or less in height.

Picture windows usually have no grille in the Queen Anne style. The only exception is when a wide horizontal grille is used to simulate the look of a cottage front window. The grille should be placed $\frac{3}{10}$ of the way down from the top of the window.

• ANDERSEN AUTHENTICITY •

To make a picture window look like a cottage style window, or when you need to use a casement window to meet egress codes, Andersen offers a 2 ¼" wide grille that can be positioned horizontally across the window to simulate a check rail, giving it the appearance of a double-hung window.

ALTERNATIVE DOUBLE-HUNG WINDOW GRILLE PATTERNS

Primary Windows

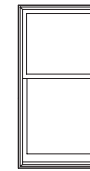

Cottage double-hung window without grilles

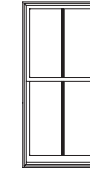

2-over-2 grille pattern

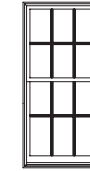

6-over-6 grille pattern

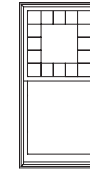

Art glass in top sash

ALTERNATIVE TRANSOM WINDOW GRILLE PATTERNS

Accent Windows

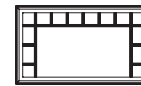

Quintessential grille variation, ideal for units of 20" or less in height

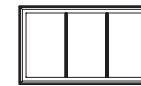

3-panel variation. Ideal for Queen Anne houses that have Federal or Georgian grille patterns in the windows

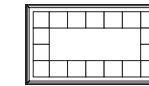

Art glass



Custom divided light grille pattern

ALTERNATIVE PICTURE WINDOW GRILLE PATTERNS

Primary Windows

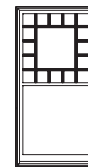

Simulated check rail with quintessential grille pattern

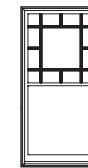

Simulated check rail with quintessential grille variant



Simulated check rail without grilles

Door Proportions

Main entry doors and auxiliary doors are taller than they are wide. While many Queen Anne style main entries consist of a single door, double doors are nearly as common. When double doors are used, each individual door is usually narrow, so the unit as a whole maintains its tall proportions.

TYPICAL PROPORTION RATIOS – MAIN DOORS

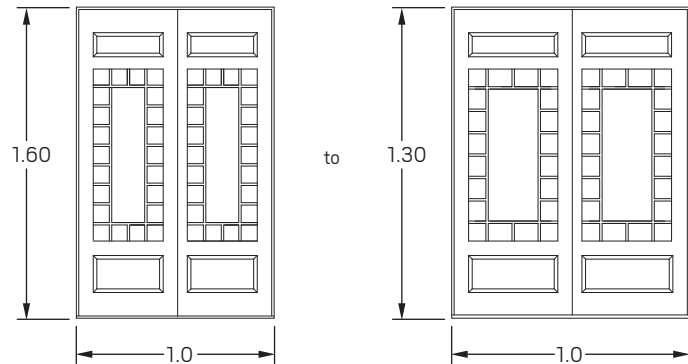

TYPICAL PROPORTION RATIOS – AUXILIARY DOORS

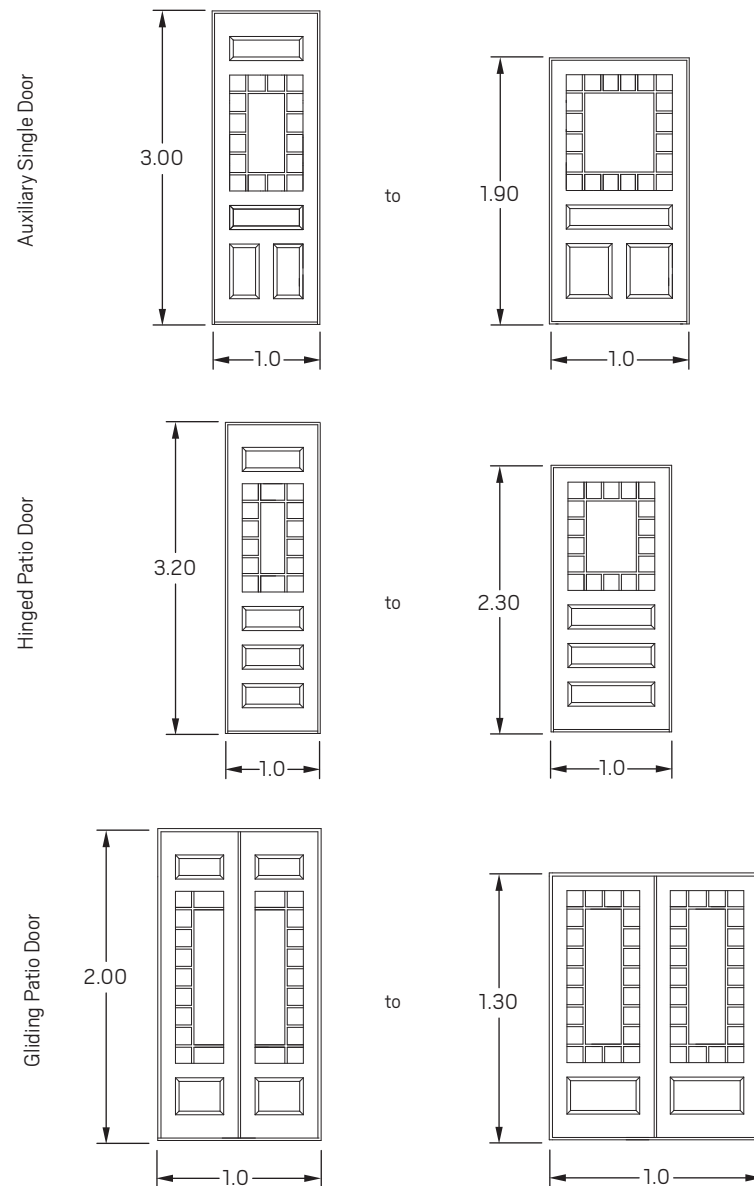

Main Entries with Trim

The Queen Anne style entry door usually has a paneled appearance and features art glass in the top half. A transom window, either with art glass or with a decoratively painted house number, is also typical. Door trim usually matches the window trim on the exterior and the interior respectively, although it's not uncommon for the main entry door trim to be more ornate.

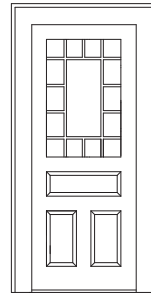

Single entry door with trim

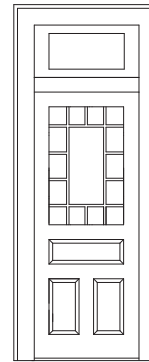

Single entry door with rectangular transom

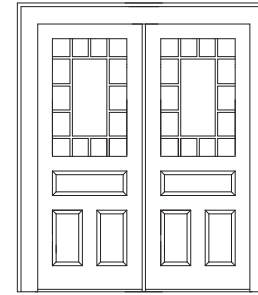

Double entry door with trim

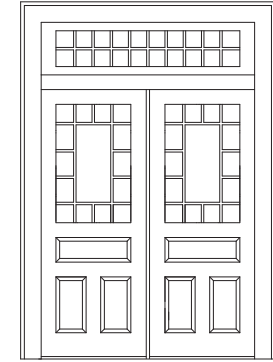

Double entry door with rectangular transom

Auxiliary Entries with Trim

The side or back door is usually a single door with wood grilles or a hinged patio door with art glass.

• ANDERSEN AUTHENTICITY •

Andersen® E-Series doors offer real-wood, raised-panel inserts that are popular in many Queen Anne style homes. The interior door panel is available in nine wood species and a large choice of finish options, including custom, to match any room. The exterior panel is made of formed aluminum cladding and offers a choice of 50 colors or any custom color.

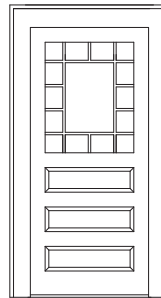

Side door with trim

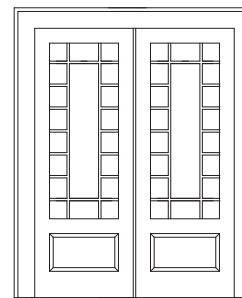

Hinged patio door with trim

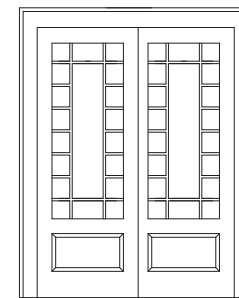

Gliding patio door with trim

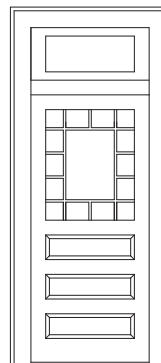

Side door with transom

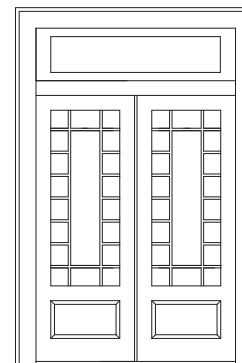

Hinged patio door with transom

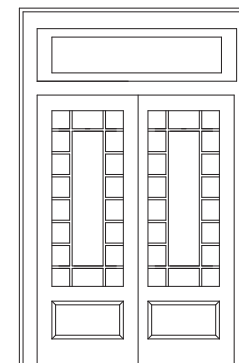

Gliding patio door with transom

Window Hardware

Window hardware embraces the mass production methods of the Victorian era and is elaborately decorated. Double-hung windows, which are the main window type in the Queen Anne style, feature sash locks and sash lifts in either antique brass, polished brass or oil rubbed bronze finishes. Satin nickel is also an alternative.

DOUBLE-HUNG HARDWARE



WINDOW HARDWARE FINISH OPTIONS

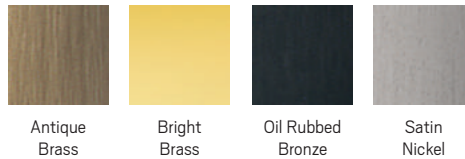

Printing limitations prevent exact finish replication. Please see your Andersen supplier for actual finish samples. Oil Rubbed Bronze is a "living" finish that will change with time and use.

Door Hardware

Like window hardware, hardware for doors is elaborately decorated. The Italianate doors found in many Queen Anne style homes are often substantial, with the hardware also being of considerable size and weight. Handles, deadbolts, door knockers and mail slots are standard for front doors and are usually finished in antique brass, polished brass or oil rubbed bronze. Satin nickel is also an option.

•ANDERSEN AUTHENTICITY•

Andersen offers hardware choices that are ideal for Queen Anne style homes. Whitmore hardware features graceful curves and a decorative rope border, while Covington hardware offers an ornate appearance that perfectly complements the Queen Anne style. Both are made of solid, forged brass to provide the substantial look and feel of the Victorian era. Plus, both are available in a range of finishes authentic to the period, including antique brass, polished brass and oil rubbed bronze.

DOOR HARDWARE

Gliding



Hinged



WHITMORE®

Antique Brass

Gliding



Hinged



COVINGTON™

Bright Brass

DOOR HARDWARE FINISH OPTIONS



Antique
Brass



Bright
Brass

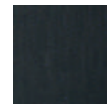

Oil Rubbed
Bronze



Satin
Nickel

Printing limitations prevent exact finish replication. Please see your Andersen supplier for actual finish samples. Oil Rubbed Bronze is a "living" finish that will change with time and use.

Exterior Trim Style Elements

Exterior trim styles range from simple, flat board trim with drip caps to elaborately carved jamb trim and pediments. The various trim components are often painted in different colors.

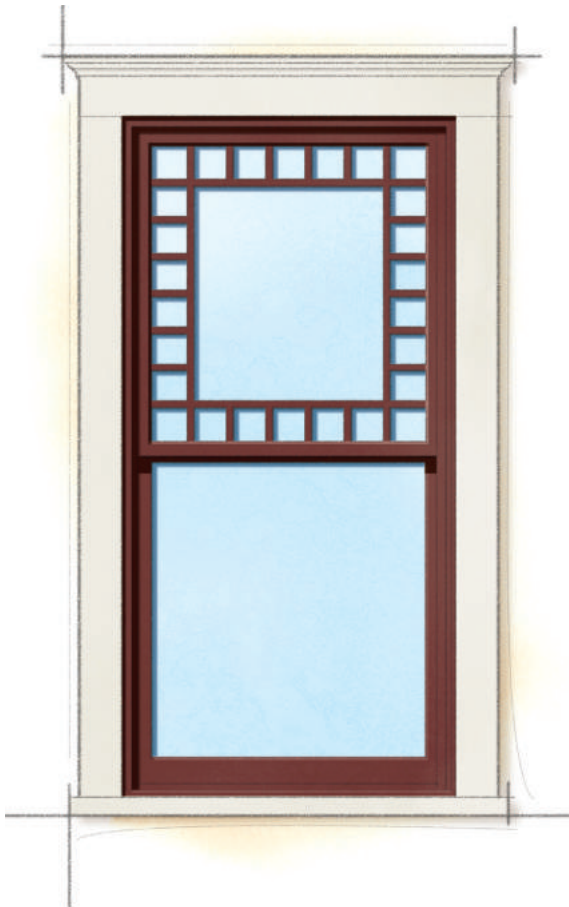

ALTERNATIVE EXTERIOR TRIM STYLES

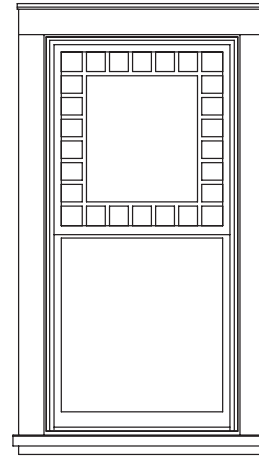

Flat casing for jambs and head with decorative drip cap. Extended sill nose with apron.

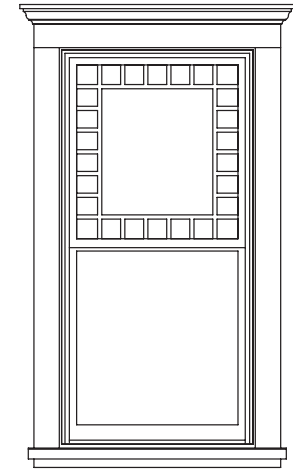

Flat casing for jambs and head with 3 5/8" cornice. Extended sill nose with apron.

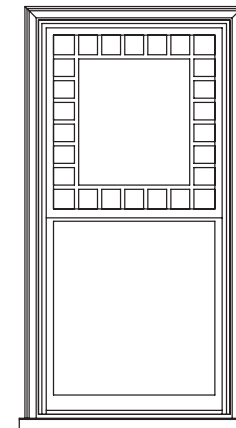

Brick mould casing for jambs and head with extended sill nose.

• ANDERSEN AUTHENTICITY •

For authentic Queen Anne styling, or to create a variance all your own, A-Series products provide a choice of three exterior trim profiles and three head trim options. A-Series exterior trim is available in 11 colors, so you can match or complement your window and door colors to create a variety of looks.

For historical accuracy, our E-Series windows and doors are available with up to 5½" flat trim, as well as expandable brick mould casing to re-create the look of backband.

You can also design your own custom trim profiles with E-Series products, plus match or contrast the trim of the windows and doors with any of 50 exterior colors, custom colors and anodized finishes.

To learn more about Andersen® trim options, visit andersenwindows.com/exteriortrim.

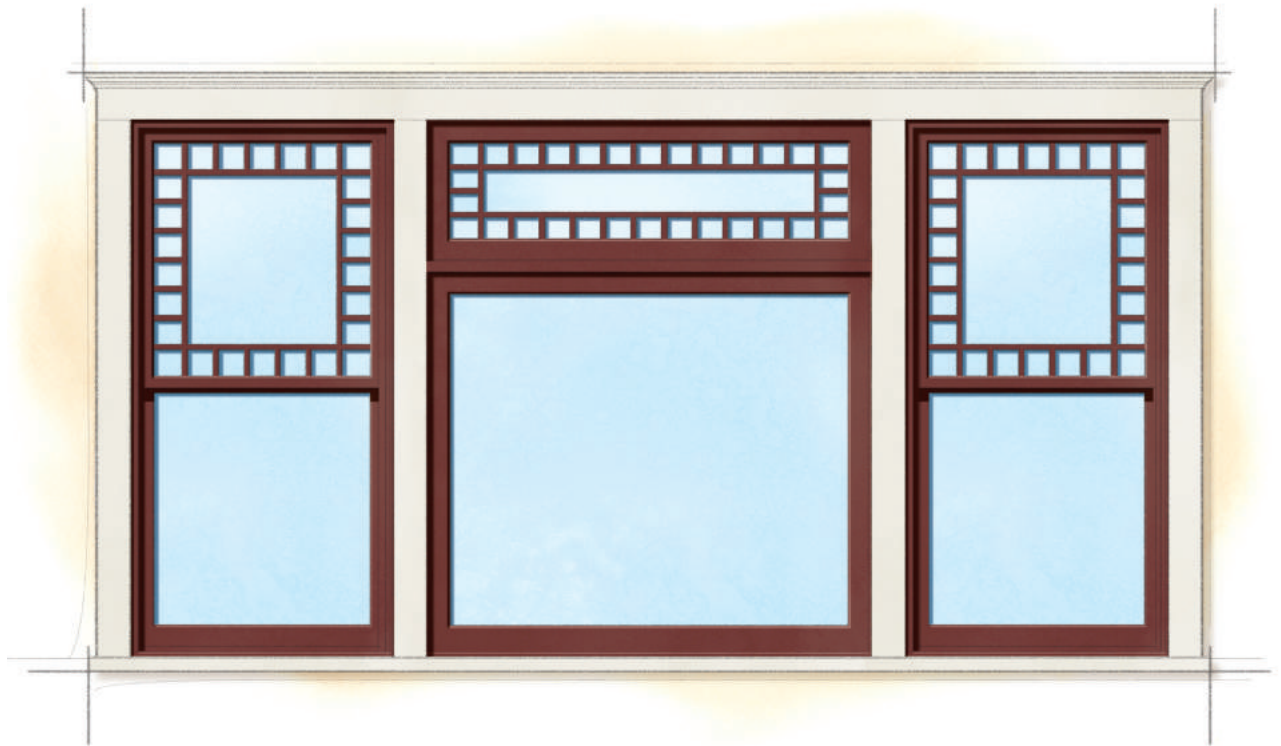

Interior Trim Style Elements

Interior trim ranges from simple, flat board trim with rosettes to elaborately carved pediments and other neo-classical ornamentation. The trim is occasionally integrated into large areas of paneling and can be either painted or stained.



ALTERNATIVE INTERIOR TRIM STYLES

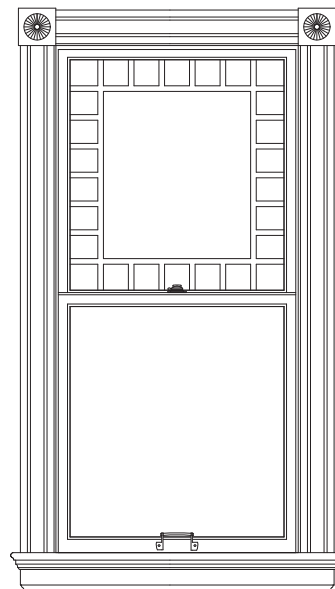

Double-banded casing with ogee chamfer and sunburst corner rosettes. Stool with bull nose and cove edge profile. Apron with ogee edge profile and enhanced with brick mould.

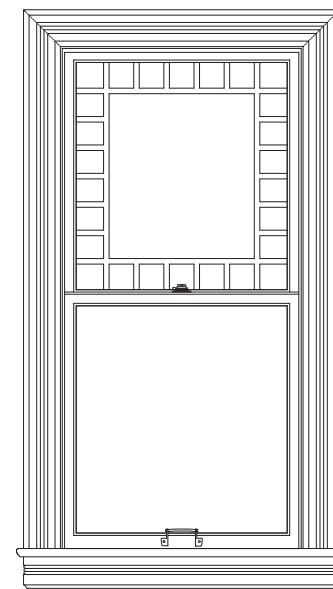

Triple-beaded casing with straight chamfer edge profile. Stool with elliptical bull edge. Apron cut from casing.

ALTERNATIVE GROUPING AND INTERIOR TRIM STYLES

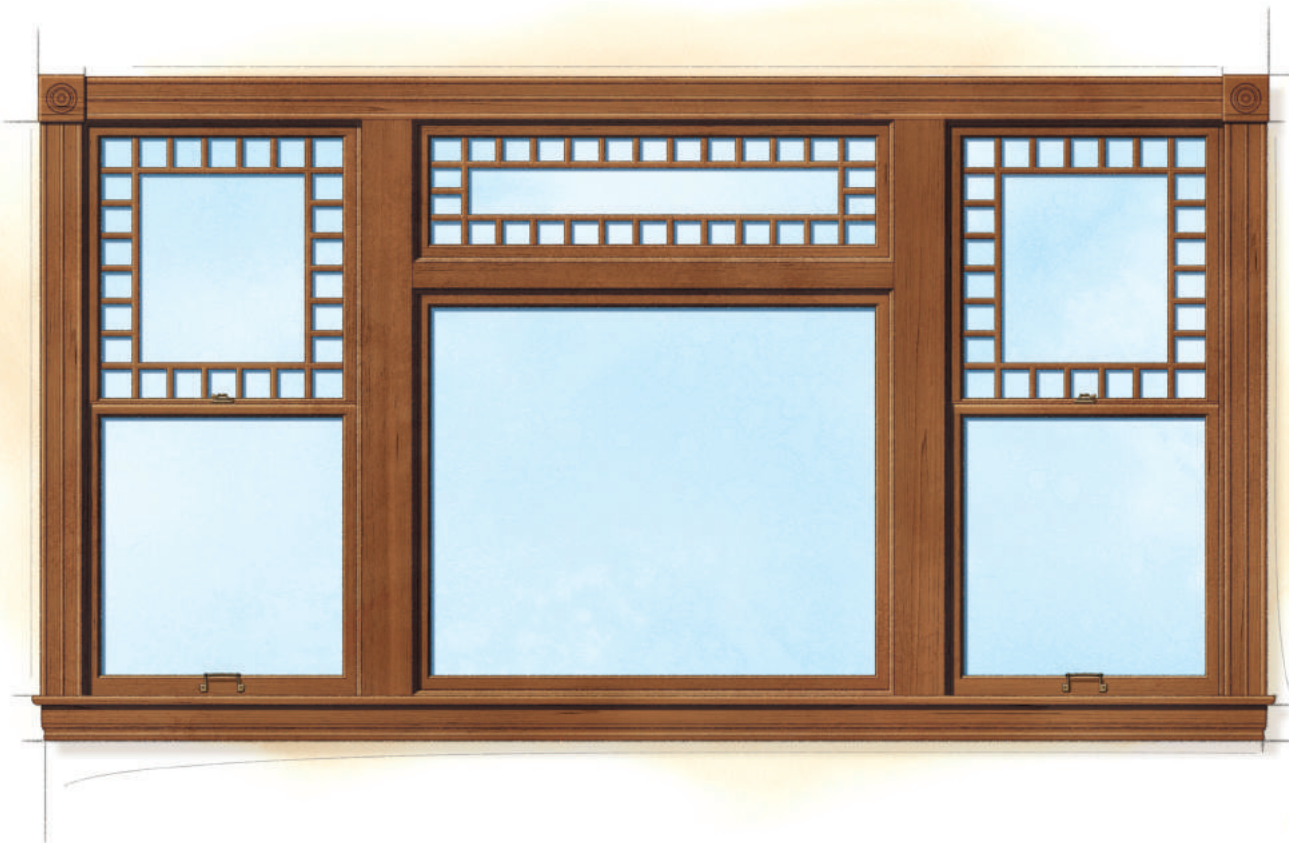

Groupings shown with narrow mull spacing.

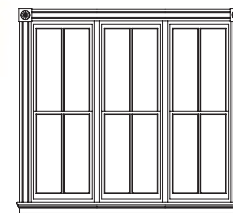
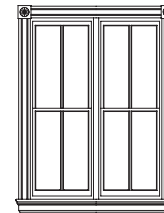

Groupings shown with wide mull spacing.

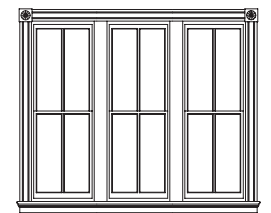
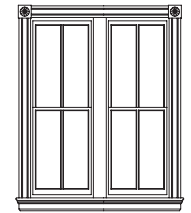

Window, Door & Trim Proportionality

Choosing the right combination of interior trim profiles and size requires careful consideration of everything from house style and room dimensions to furnishings and room function.

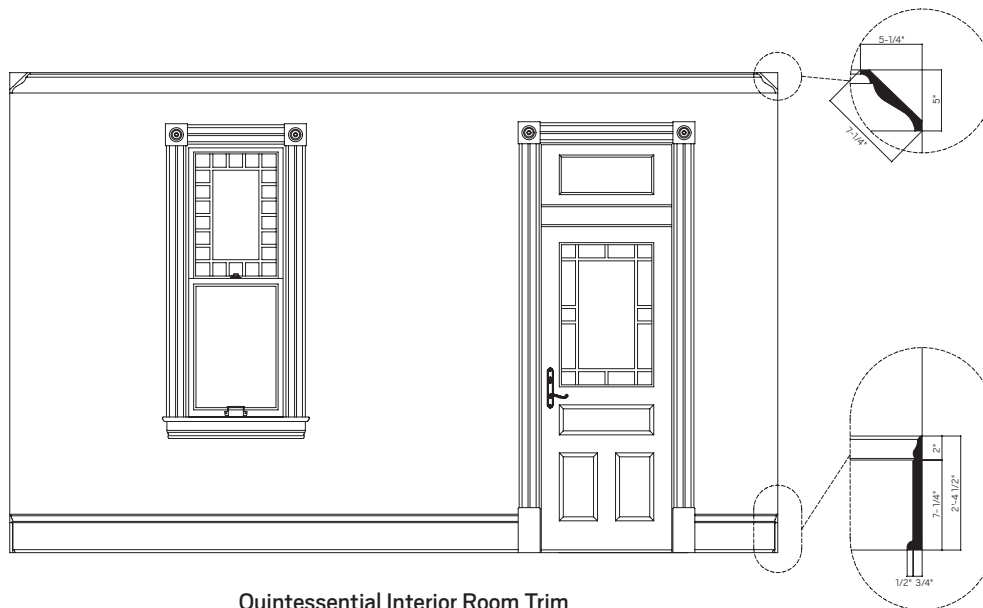

Quintessential Interior Room Trim

Room ensemble showcasing typical vertical proportions of Queen Anne style. Tall baseboard with base shoe and cap molding, as well as a plinth block at the base of the door casing to visually anchor the door casing. Rosettes with concentric bead profile transition the casing at the corners of the room.

Art Glass Style

Art glass is a common decorative element in Queen Anne homes and greatly adds to the home's ornate style. Patterns range from classical Renaissance designs to the more flowing, nature-inspired Art Nouveau motifs.

Typical Art Glass Location

The most popular locations for art glass in the Queen Anne style are front cottage windows, accent windows and bay windows.

•ANDERSEN AUTHENTICITY•

Andersen offers several art glass designs that complement Queen Anne style architecture, including Queen Anne, Regency, Victoria and Diamond Lights.

Each design is available in a wide range of sizes and shapes, and in a combination of clear and colored glass or clear glass only.

For more information, visit andersenwindows.com/artglass.

HISTORIC AND CLASSIC SERIES*

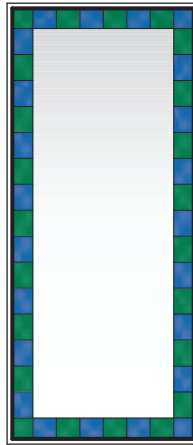

Queen Anne

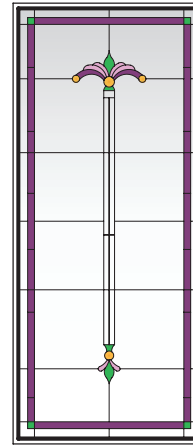

Regency



Queen Anne Design

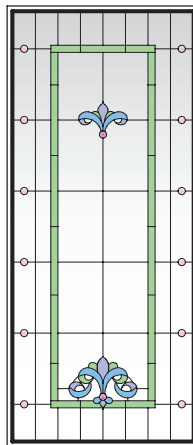

Victoria

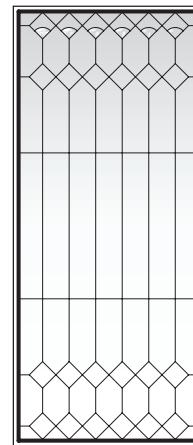

Diamond Lights



Victoria Design

*Classic Series glass patterns are available with semiprivacy glass or clear antique glass in place of colored glass (except where indicated).

Queen Anne Andersen® Product Index



Double-hung window (exterior)

- 4½" flat exterior trim with 2" cornice: White
- Frame exterior: Red Rock
- Sash exterior: Red Rock
- Queen Anne grille pattern

Shown on pages 5, 6, 8 and 20.



Double-hung, picture and transom window combination (exterior)

- 4½" flat exterior trim with 2" cornice: White
- Frame exterior: Red Rock
- Sash exterior: Red Rock
- Queen Anne grille pattern (double-hung and transom)

Shown on pages 5 and 21.



Hinged inswing patio door (exterior)

- 4½" flat exterior trim with 2" cornice: White
- Frame exterior: Red Rock
- Panel exterior: Red Rock
- Queen Anne grille pattern
- Whitmore® door hardware: Antique Brass

Shown on page 5.



Double-hung window (interior)

- Frame interior: Maple with Cinnamon finish
- Sash interior: Maple with Cinnamon finish
- Queen Anne grille pattern
- Traditional double-hung lock and keeper and bar lift: Antique Brass

Shown on pages 6, 8 and 22.



Double-hung, picture and transom window combination (interior)

- Frame interior: Maple with Cinnamon finish
- Sash interior: Maple with Cinnamon finish
- Queen Anne grille pattern (double-hung and transom)
- Traditional double-hung lock and keeper and bar lift: Antique Brass

Shown on page 23.



Straightline glass panel double door (194) (exterior)

- 4½" flat exterior trim: White
- Panel exterior: Oak with Cinnamon finish
- Custom Queen Anne art glass
- Whitmore door hardware: Antique Brass

Shown on page 7.



"Andersen" and all other marks where denoted are trademarks of Andersen Corporation.
©2018 Andersen Corporation. All rights reserved. 12/18 Part #9070658