



PRM 4107
RHK 180 PLK



FULL LINE DOOR CATALOG

BEAUTY. STRENGTH. DURABILITY.



KAL 20 SRP



PRM 730

TABLE OF CONTENTS

WOODGRAIN DOORS OVERVIEW

BEAUTY. STRENGTH. DURABILITY.	5
OUR HISTORY	5
OUR COMMITMENT	5

DOOR SELECTION PROCESS

SELECTING THE RIGHT DOOR	9
QUALITY CRAFTSMANSHIP	9
STILE & RAIL DOOR CONSTRUCTION	9
CHOOSE A DOOR TYPE	10
PERSONALIZE WITH SPECIES	12
PERSONALIZE WITH GLASS	14

INTERIOR

RAISED PANEL	16
FLAT PANEL	18
PLANK PANEL	20
BARN	22
LOUVER & CAFE	24
BILLFOLD	26
DECORATIVE GLASS & UTILITY	28
TRADITIONAL & CONTEMPORARY FRENCH	30
SASH	32
DESIGN COLLECTION PRIMED MDF	34
DUTCH	44
FIRE RATED DOORS	46

EXTERIOR

PLANK PANEL	47
RAISED PANEL	50
SASH	52
CRAFTSMAN	56
SIDELIGHTS	58
TRANSOMS	60

FINISHING

FITTING AND HANGING	64
-------------------------------------	----

STORING AND HANDLING	64
--------------------------------------	----

MAINTENANCE	65
-----------------------------	----

WARRANTY	67
--------------------------	----

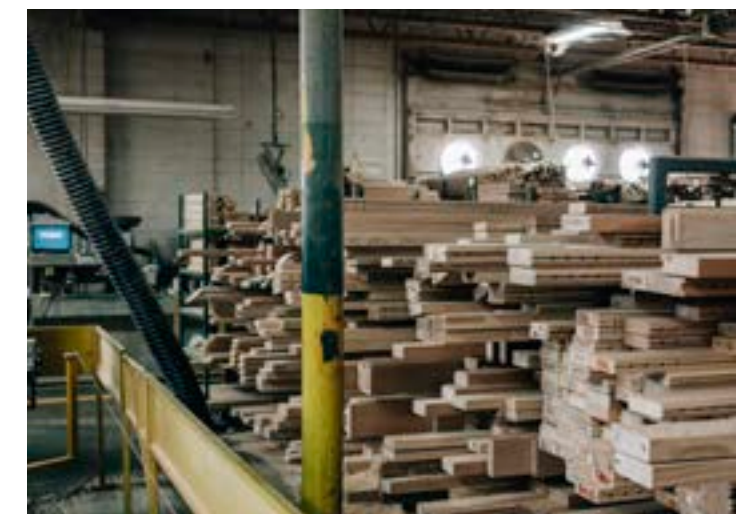
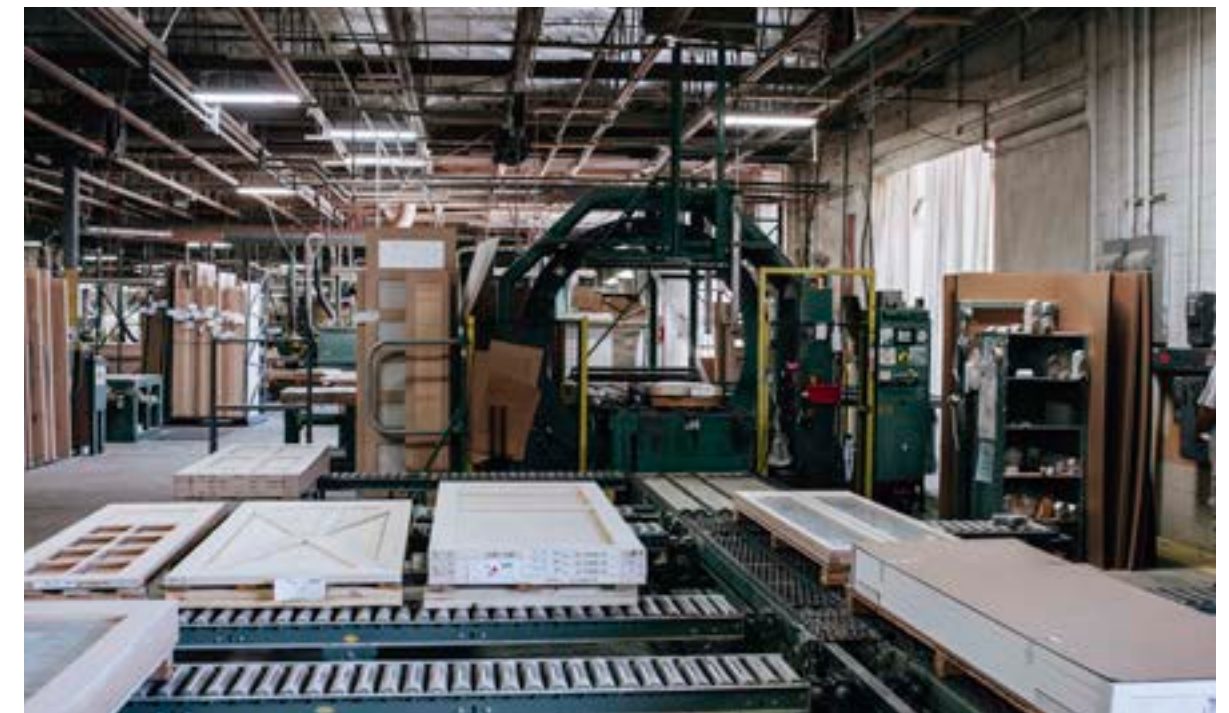
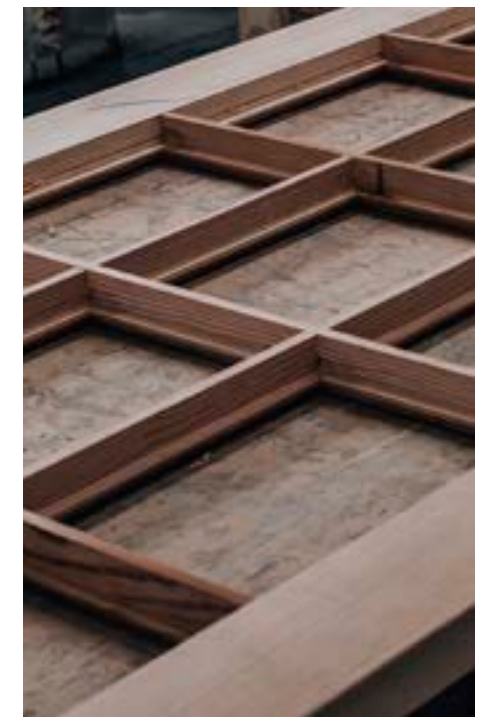
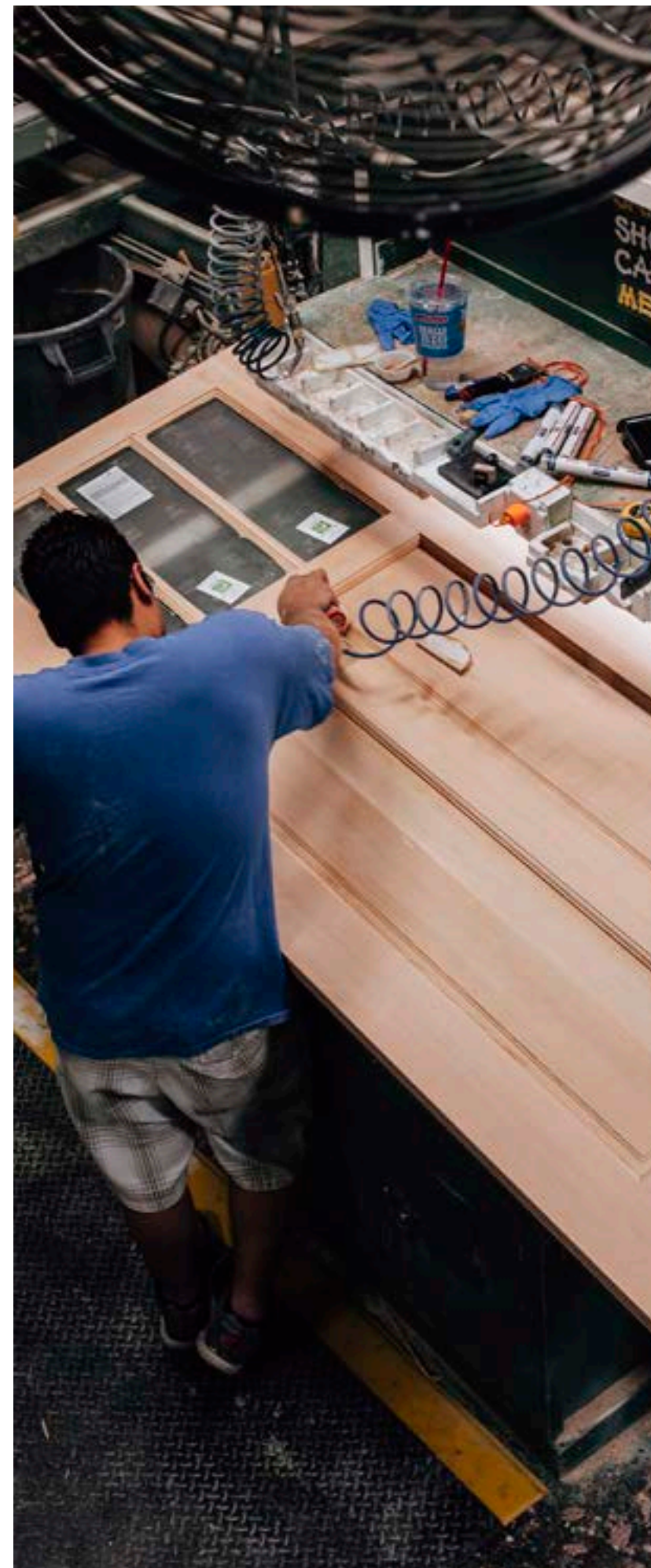



WOODGRAIN OVERVIEW

BEAUTY. STRENGTH. DURABILITY.

Woodgrain Doors combines beauty, strength and durability in every door we offer. Our finely crafted doors connect your most cherished indoor and outdoor spaces. By combining the breadth of styles, designs and customizable options Woodgrain Doors offers with the superior craftsmanship of our products, you're sure to find a door to meet your functional needs while also enhancing the charm of your home.

Woodgrain Doors is one of the world's leading manufacturers and suppliers of hardwood and softwood stile and rail doors, and door components. Distributors, builders, remodelers, architects, designers and homeowners rely on Woodgrain products to build quality homes. Woodgrain is committed to innovation through continuous improvements in manufacturing, investment in design, excellence in craftsmanship and use of the highest quality raw materials to build doors that are as durable as they are beautiful.

OUR HISTORY

Woodgrain has manufactured millwork and building products for the residential and commercial construction markets since it was founded in 1954. In over 65 years in business, the company has expanded with millwork, distribution, doors and window divisions — making Woodgrain the preferred leader in the construction and home building industry.

Woodgrain Doors began in 1985 with the acquisition of Meridian Wood Products by our parent company, Woodgrain Millwork. Woodgrain Doors is headquartered in Nampa, Idaho and manufactures and distributes hundreds of thousands of doors annually.

OUR COMMITMENT

In our total commitment to the environment, Woodgrain promises to act as a responsible corporate citizen, optimizing our use of resources and producing products that have a positive impact on the environment and the health of people. The wood used by Woodgrain primarily originates from sustainable sources. Our manufacturing processes ensure over 99% of the wood fiber is used as a product. Woodgrain recycles every product possible and strives to operate in an environmentally conscious manner.



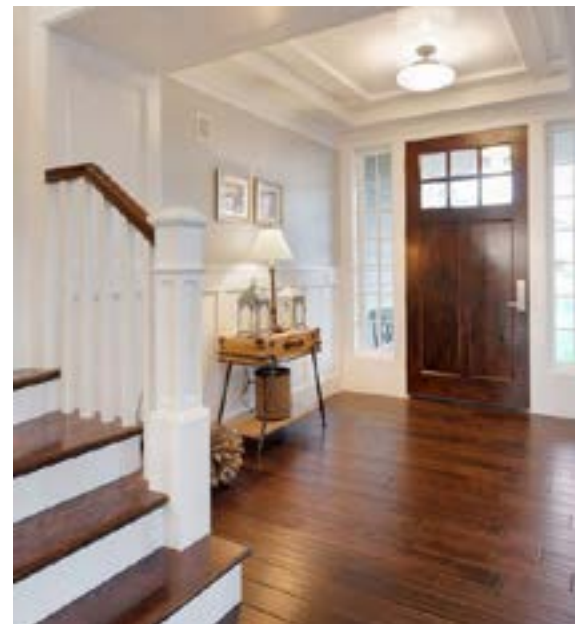

DOOR SELECTION PROCESS

SELECTING THE RIGHT DOOR

From traditional to contemporary styles, choose features such as panel, glass, size and species for your ideal door:

- Determine application – Interior, Exterior, Barn or Rolling Door, Fire Door, Etc.
- Determine your size
- Choose a door design and type
- Pick a specie
- Select from the panel options
- Upgrade with add-ons

To learn more about Woodgrain Doors, visit: woodgraindoors.com

QUALITY CRAFTSMANSHIP MEETS SUPERIOR PERFORMANCE

Woodgrain Doors' exquisite collection offers a unique combination of beauty and durability. Built upon our superior, quality craftsmanship, we uphold the industry's highest standard of authentic stile and rail construction. With thousands of door designs, styles and configurations to choose from, you'll find the perfect door to complement your unique style.

DUTCH DOORS AND CUSTOM APPLICATIONS

As a stock door slab manufacturer, Woodgrain Doors is able to provide customers the materials they need to let their craftsmanship and creativity thrive. Mount any of our unique door profiles to barn door hardware and create a contemporary and custom feel for less. Remanufacture a number of our profiles, by cutting them down the middle to create a dynamic Dutch door. These are just a few alternative ways to use Woodgrain door slabs.

STILE AND RAIL DOOR CONSTRUCTION

Panel options for each category show an end view of the panels available.

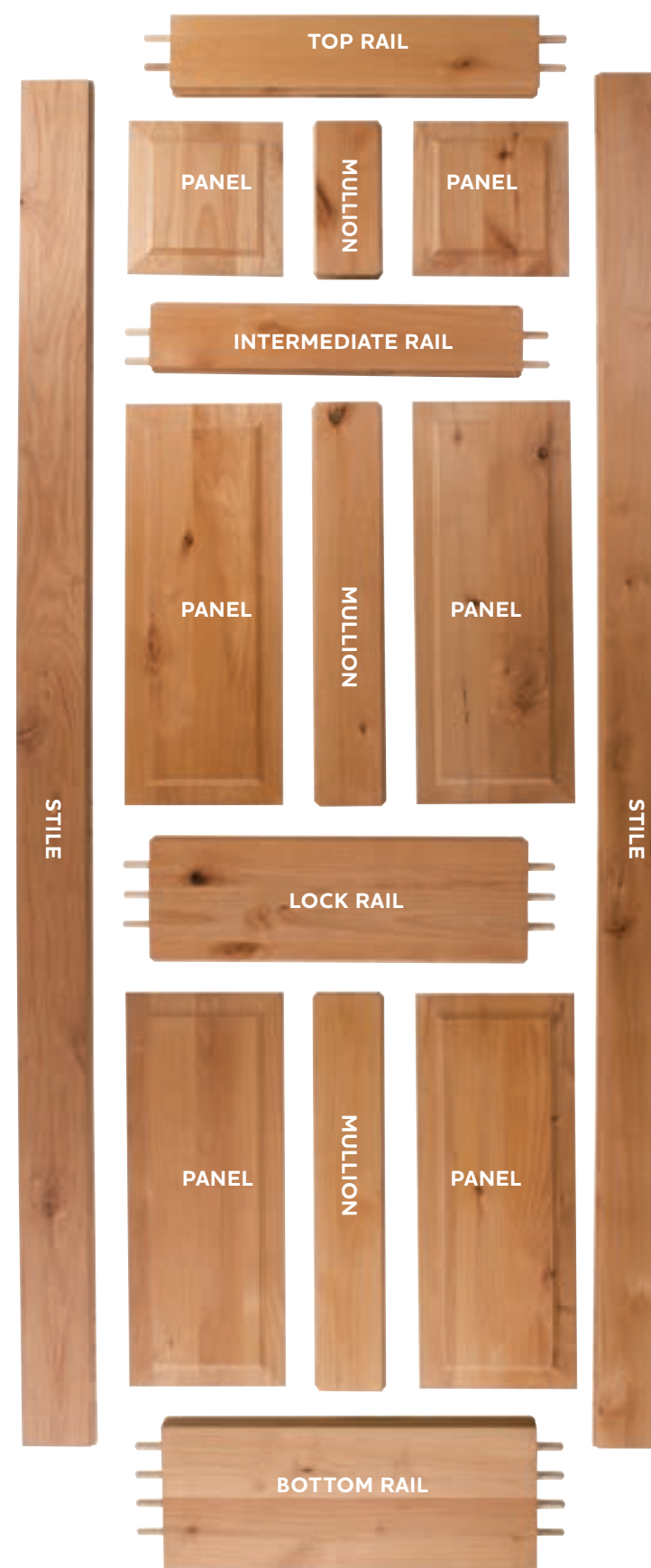

PERSONALIZE WITH TYPE



BARN DOORS

Woodgrain Doors' new Barn Door Collection is the perfect fit for modern, contemporary, and rustic applications. Built upon our superior quality craftsmanship, each barn door features either a 3/4" panel design to highlight the definition and elegance of the v-groove. The mulls in each layout are full thickness and engineered to meet flush with the stiles and rails to provide a unique combination of beauty, strength and durability. Barn Doors allow you the flexibility to enhance an entire room with a unique accent piece, while also adding more functionality to your space. From master suites to pantries, barn doors give you the flexibility to customize your space.



BIFOLD DOORS

Woodgrain's bifold doors are crafted with state-of-the-art technology to ensure consistent precision assembly. Bifold doors are ideal for smaller spaces, including closets, laundry rooms and any area where space is at a premium. Bifold doors come with all the necessary hardware for installation.



CAFÉ DOORS

Woodgrain's café doors admit light and ventilation, and provide minimal privacy. The café doors come as a pair and swings open – in and out – in both directions for easy flow.



CRAFTSMAN DOORS

Make a memorable first impression with a Woodgrain craftsman door. The collection of exterior doors is built with unsurpassed craftsmanship and extensive design and glass options offering natural warmth and beauty to your home. All craftsman doors are built with true divided lite construction (TDL) and Low E glass, meaning that each pane of glass is a unique piece of glass providing better protection and easier finishing.



DECORATIVE GLASS DOORS

Customize your home with Woodgrain's interior decorative glass doors. Choose from geometric patterns in a variety of styles and finishes.



PRIMED MDF DOORS

The Woodgrain design collection of medium density fiberboard (MDF) includes infinite options including personalized options with our auto-CAD technology. Available in fire-rated options. California 93120 CARB Compliant for Formaldehyde Phase 2 and TSCA Title VI certified or compliant.



FLAT PANEL DOORS

Woodgrain offers interior flat panel doors in a variety of wood species. Flat panel doors offer crisp lines and provide a versatile look that complements both modern and traditional interiors. Available in fire rated options.



DUTCH DOORS

Woodgrain offers a number of interior and exterior doors in a variety of wood species that can be easily altered to create custom Dutch doors. Dutch doors create a versatile look that complements both modern and traditional interiors.



LOUVER DOORS

Woodgrain's louver doors provide a beautifully functioning door with a touch of subtle charm between passageways. Each door is designed to provide privacy and ventilation, and ideal for closets and other spaces that require maximum air circulation. Louver doors are a sensible choice for hallways, closets and storage rooms.



PLANK PANEL DOORS

Woodgrain offers interior and exterior plank panel doors in a variety of wood species. Plank panel doors offer added dimension to complement traditional and contemporary styles.



RAISED PANEL DOORS

Woodgrain offers interior and exterior raised panel doors in a variety of wood species. Raised panel doors offer added dimension to complement traditional and contemporary styles.



SASH DOORS

Woodgrain sash doors include an assortment of handcrafted doors to complement any decor. All sash doors are built with true divided lite construction (TDL), meaning that each pane of glass is a unique piece of glass providing better protection and easier finishing. A variety of interior and exterior designs with numerous light and panel configurations available.



SIDELIGHTS

Woodgrain glass doors also include a variety of sidelights to complement any door. Adding sidelights to either or both sides of your door will increase the impact of your door by inviting natural light into the home at entry or patio doorways. Sidelights are available in insulated or single glazed glass.



TRADITIONAL AND CONTEMPORARY FRENCH DOORS

Woodgrain traditional French doors offer an assortment of handcrafted doors to complement any decor. All French glass doors are built with true divided lite construction (TDL), meaning that each pane of glass is a unique piece of glass providing better protection and easier finishing. A variety of interior and exterior design options are available.



TRANSOMS

Woodgrain glass doors include a variety of transoms to complement any door. Adding a transom above your door will extend the height of your door and allow natural light into the home at entry or patio doorways. Transoms are available in insulated or single glazed glass.



UTILITY DOORS

Customize your home with a utility door in Laundry, Pantry or Wine Cellar.

PERSONALIZE WITH SPECIES



CHY — Cherry

Cherry grows in the Eastern and Midwestern United States and comes in a range of colors including white, light red, deep red and reddish brown. Cherry has a fine, uniform straight grain and a smooth texture. Cherry accepts a variety of stains and finishes.



FIR — Douglas Fir

Douglas Fir is a large, generally vertical-grained tree that grows in abundance in the Pacific Northwest. Douglas Fir is characterized by exceptional natural strength, hardness and durability. The wood varies in color from yellowish tan to light, bright brown.



KAL — Knotty Alder

Knotty Alder grows in the Pacific Northwest and is a medium density hardwood with an even grain appearance. The wood is normally light brown with hues of red or peach. Its softer nature makes it easy to machine and receptive to a variety of stains and finishes.



KPN — Knotty Pine

Knotty Pine is abundant in America. The wood has a rich display of knots that reflects the randomness and beauty of nature. The wood tends to be a honey-toned or straw color while the knots are generally reddish-brown.



MHG — Mahogany

Mahogany is characterized by its natural strength, proven durability and a rich red color. Its straight grain is usually free of voids and pockets, making it a premium hardwood known for use in high-end furniture making. Khaya Mahogany is the Woodgrain standard MHG door: range and mix of colors in door parts and components from light blonde to dark brown. For more uniform, consistent color in MHG door we have premium Sapele MHG as upgrade. *khaya MHG standard, premium Sapele available on request



MPL — Maple

Maple grows in the Eastern United States, offers a very fine grain and a white-ish color tinged with reddish brown.



OAK — Northern Red Oak

Hard and heavy, Oak grows mainly in the North Central United States. With a coarse texture and a straight, prominent grain, oak accepts a broad range of stains and finishes.



PON — Ponderosa Pine

Ponderosa Pine is one of America's most abundant tree species. It has straight, uniform grain with minimal amounts of reddish-brown heartwood. The sapwood has wide growth bands, which are honey-toned or straw-colored.



POP — Poplar

Poplar grows in the Eastern United States. Colors of Poplar vary from brown to pale yellow to olive green. Over time, the green color will darken with exposure to sunlight and may turn brown. Poplar is a medium density hardwood, generally straight-grained with a fine, even texture.



PRM — Primed

Woodgrain's multiple door configurations have a primed option to allow for a better paint finish and color match process for any project. Interior applications are produced with MDF veneer and panels for superior paintability. MDF Design Collection Router Carved doors are also available.



RAD — Radiata Pine

Radiata Pine is a plantation-grown wood from Chile, New Zealand and Australia. It has a distinctive grain pattern with a pale cream color. Radiata tends to be harder than other pine species and has fewer knots.



RHK — Rustic Hickory

This unique species will have many variations allowed in the wood for character. Mineral, sap, bird pecks, heartwood and knots are common. Color may vary from a dark brown to white. Rustic Hickory is often clear coated or stained lighter shades to showcase the natural beauty of the species.



WAL — Walnut

Walnut grows throughout the eastern United States. Its color ranges from a medium light to chocolate brown. Walnut is generally straight grained with a course texture. It is a dense wood and accepts a variety of stains and finishes.

SIZES

OUR DOORS AND BIFOLDS COME IN A VARIETY OF STANDARD SIZES, RANGING FROM:

- 6'8", 7'0", 7'6" and 8'0" heights
- 0'10" to 6'0" widths
- 1-3/8" and 1-3/4" thicknesses*

While not all sizes and panel configurations are available in all options, Woodgrain Doors can accommodate many custom orders such as replacing a panel with glass.

All species shown are clear coated.

*2' 1/4" available in select species and styles.

PERSONALIZE WITH GLASS

Woodgrain Doors offers 24 glass options to further customize your door. Choose from either a Clear Single Glazed or Insulated Low E glass types. Clear Single Glazed is a single piece of tempered glass whereas Low E Insulated is coated and insulated, which allows it to reflect radiant heat, making it a more energy efficient option.

PRIVACY:

























- 10
- 9
- 8
- 7
- 6
- 5
- 4
- 3
- 2
- 1

























This indicates the amount of privacy that each glass profile allows through it 1 being little privacy and 10 being full privacy.

LIGHT:

- 10
- 9
- 8
- 7
- 6
- 5
- 4
- 3
- 2
- 1

This indicates the amount of light that each glass profile allows through it 1 being lots of light and 10 being no light.

		1 1			3 2			5 5
CLEAR			ARTIQUE			BAMBOO		
		2 1			6 5			7 6
BEVEL			CHARCOAL STICKS			COTSWOLD		
		5 4			8 7			7 6
CROSS REED			DELTA FROST			DOUBLE GLUE CHIP		
		8 9			6 5			3 2
FROSTED (FRIT)			GLUE CHIP			HEAVY WATER		

		10 10			7 6			5 4
MIRROR			#42 CLEAR			NARROW REED		
		8 8			7 7			2 2
OBSCURE			RAIN			SEEDY		
		7 6			4 4			9 8
SYCAMORE			TAFFETA			RIBBED		
		9 9			9 9			2 1
WATER DROP			WHITE LAMINATED			V-GROOVE		

Not all glass options are available in all styles or species.
Our glass meets the following standards: ANSI Z97.1 and 16CFR 1201 C II.

INTERIOR RAISED PANEL DOORS

SPECIFICATIONS

- 6'8", 7'0" and 8'0" heights
- 1'0" to 3'0" widths
- 1-3/8" and 1-3/4" thicknesses
- Square, Arch and Eyebrow Tops
- Fire Rated (available on 1-3/4" only)

PANEL PROFILES

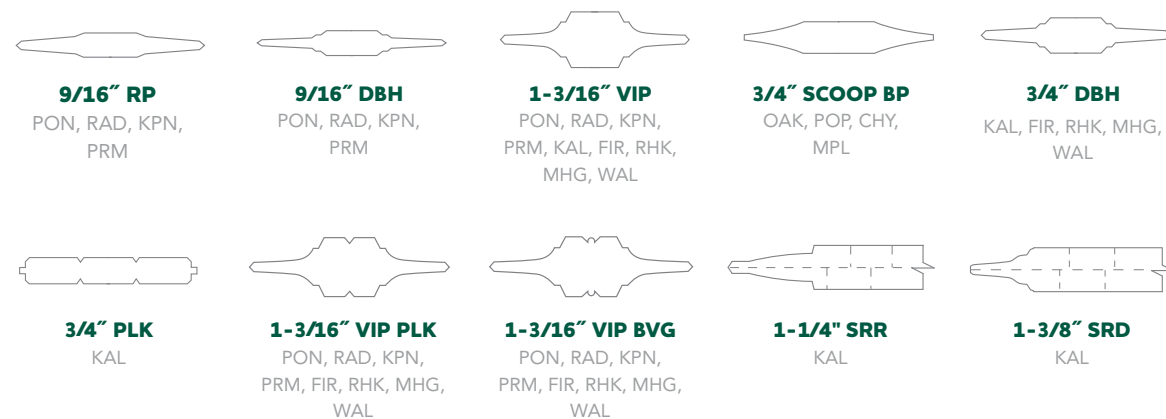

For FIRE rated door information see [page 46](#)

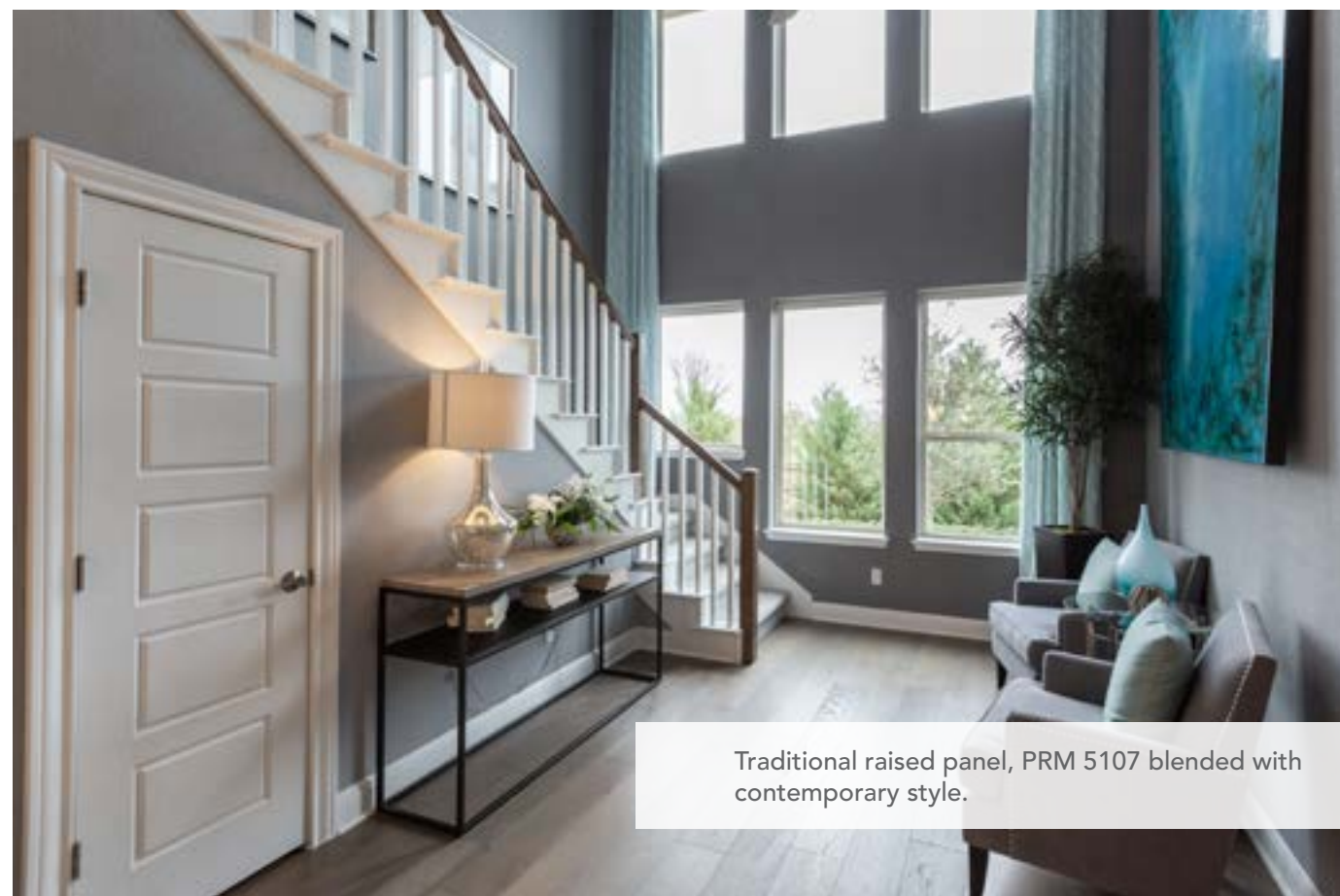

Traditional raised panel, PRM 5107 blended with contemporary style.



- | | | | | | | |
|--|--|---|---|--|---|---|
| 20
PON, RAD, KPN,
PRM ¹ , KAL, FIR,
RHK, MHG, WAL | 100
PON, RAD, KPN,
PRM ¹ , OAK, MPL,
POP, CHY | 102
PON, RAD, KPN,
PRM ¹ , OAK, MPL,
POP, CHY, KAL,
FIR, RHK, MHG,
WAL | 103
PON, RAD, KPN,
PRM ¹ , OAK, MPL,
POP, CHY, KAL,
FIR, RHK, MHG,
WAL | 103T
PON, RAD, KPN,
PRM ¹ , OAK, MPL,
POP, CHY, KAL,
FIR, RHK, MHG,
WAL | 106
PON, RAD, KPN,
PRM ¹ , OAK, MPL,
POP, CHY, KAL,
FIR, RHK, MHG,
WAL | 107
PON, RAD, KPN,
PRM ¹ , OAK, MPL,
POP, CHY, KAL,
FIR, RHK, MHG,
WAL |
|--|--|---|---|--|---|---|

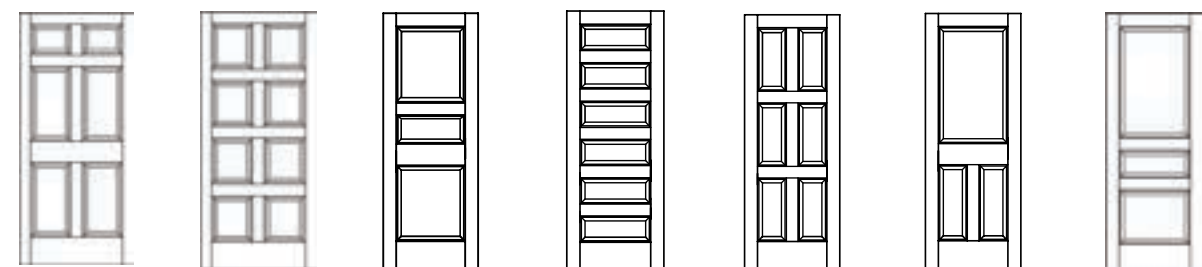

- | | | | | | | |
|---|---|---|---|--|---|---|
| 108
PON, RAD, KPN,
PRM ¹ , OAK, MPL,
POP, CHY, KAL,
FIR, RHK, MHG,
WAL | 109
PON, RAD, KPN,
PRM ¹ , OAK, MPL,
POP, CHY, KAL,
FIR, RHK, MHG,
WAL | 110
PON, RAD, KPN,
PRM ¹ , OAK, MPL,
POP, CHY, KAL,
FIR, RHK, MHG,
WAL | 112
PON, RAD, KPN,
PRM ¹ , OAK, MPL,
POP, CHY, KAL,
FIR, RHK, MHG,
WAL | 117
PON, RAD, KPN,
PRM ¹ , OAK, MPL,
POP, CHY, KAL, FIR,
RHK, MHG, WAL | 129
PON, RAD, KPN,
PRM ¹ , OAK, MPL,
POP, CHY, KAL,
FIR, RHK, MHG,
WAL | 131
PON, RAD, KPN,
PRM ¹ , OAK, MPL,
POP, CHY, KAL,
FIR, RHK, MHG,
WAL |
|---|---|---|---|--|---|---|

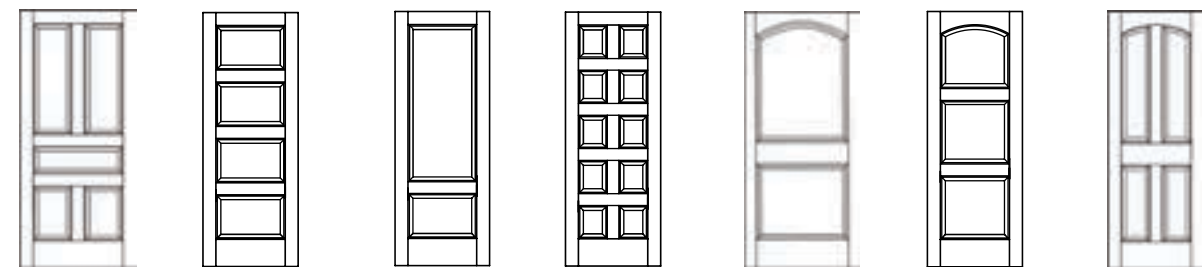

- | | | | | | | |
|---|---|---|---|---|---|---|
| 133
PON, RAD, KPN,
PRM ¹ , OAK, MPL,
POP, CHY, KAL,
FIR, RHK, MHG,
WAL | 141
PON, RAD, KPN,
PRM ¹ , OAK, MPL,
POP, CHY, KAL,
FIR, RHK, MHG,
WAL | 149
PON, RAD, KPN,
PRM ¹ , OAK, MPL,
POP, CHY, KAL,
FIR, RHK, MHG,
WAL | 158
PON, RAD, KPN,
PRM ¹ , OAK,
MPL, POP, CHY,
KAL, FIR, RHK,
MHG, WAL | 802
PON, RAD, KPN,
PRM ¹ , OAK, MPL,
POP, CHY, KAL,
FIR, RHK, MHG,
WAL | 803
PON, RAD, KPN,
PRM ¹ , OAK, MPL,
POP, CHY, KAL,
FIR, RHK, MHG,
WAL | 804
PON, RAD, KPN,
PRM ¹ , OAK, MPL,
POP, CHY, KAL,
FIR, RHK, MHG,
WAL |
|---|---|---|---|---|---|---|



- | | | | | | | |
|--|---|--|---|---|---|---|
| 806
PON, RAD, KPN,
PRM ¹ | 820
PON, RAD, KPN,
PRM ¹ , KAL, FIR,
RHK, MHG, WAL | 822
PON, RAD, KPN,
PRM ¹ | 831
PON, RAD, KPN,
PRM ¹ , OAK, MPL,
POP, CHY, KAL,
FIR, RHK, MHG,
WAL | 833
PON, RAD, KPN,
PRM ¹ , OAK, MPL,
POP, CHY, KAL,
FIR, RHK, MHG,
WAL | 842
PON, RAD, KPN,
PRM ¹ , OAK, MPL,
POP, CHY, KAL,
FIR, RHK, MHG,
WAL | 849
PON, RAD, KPN,
PRM ¹ , OAK, MPL,
POP, CHY, KAL,
FIR, RHK, MHG,
WAL |
|--|---|--|---|---|---|---|

¹ Specie is manufactured with MDF skins and panels.

INTERIOR FLAT PANEL DOORS

SPECIFICATIONS

- 6'8", 7'0" and 8'0" heights
- 1'0" to 3'0" widths
- 1-3/8" and 1-3/4" thicknesses
- 3/8" panel; *5/8" panel available on 1-3/4" doors
- Fire Rated (available on 1-3/4" only)
- Wood stile and rail components with MDF veneers and panels for superior quality painted finish



PANEL OPTIONS

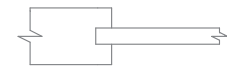

SHAKER (4000 SERIES)

PON, RAD, KPN,
PRM, OAK, MPL,
POP, CHY, KAL,
FIR, RHK, MHG, WAL

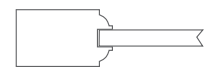

NANTUCKET (FP SERIES)

PON, RAD, KPN,
PRM, OAK, MPL,
POP, CHY, FIR, RHK,
MHG, WAL

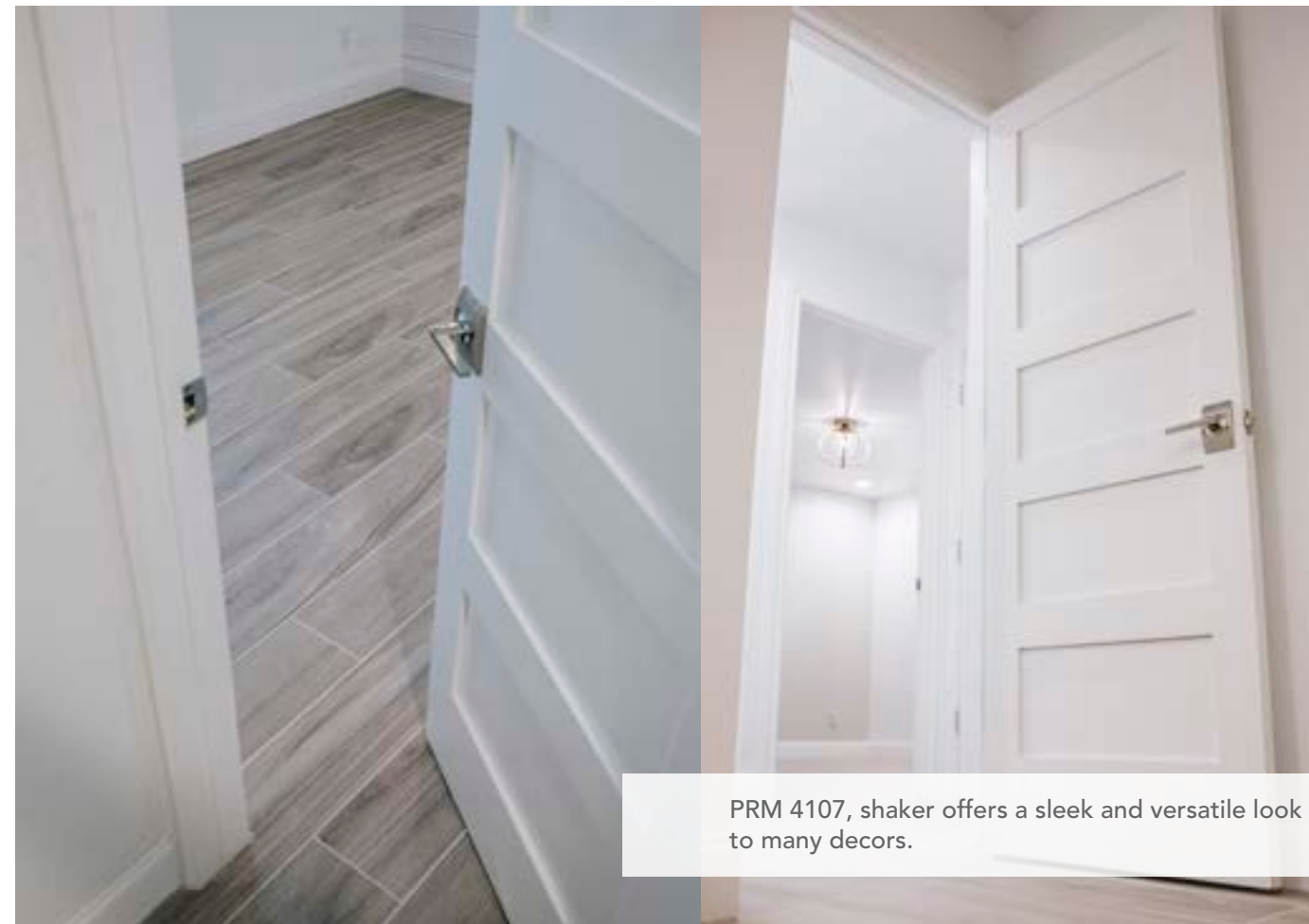

PRM 4107, shaker offers a sleek and versatile look to many decors.



20FP 4020

PON, RAD, KPN,
PRM¹, OAK, MPL,
POP, CHY, KAL²,
FIR, RHK, MHG,
WAL



102FP 4102

PON, RAD, KPN,
PRM¹, OAK, MPL,
POP, CHY, KAL²,
FIR, RHK, MHG,
WAL



103FP 4103

PON, RAD, KPN,
PRM¹, OAK, MPL,
POP, CHY, KAL²,
FIR, RHK, MHG,
WAL



103TFP 4103T

PON, RAD, KPN,
PRM¹, OAK, MPL,
POP, CHY, KAL²,
FIR, RHK, MHG,
WAL



106FP 4106

PON, RAD, KPN,
PRM¹, OAK, MPL,
POP, CHY, KAL²,
FIR, RHK, MHG,
WAL



107FP 4107

PON, RAD, KPN,
PRM¹, OAK, MPL,
POP, CHY, KAL²,
FIR, RHK, MHG,
WAL

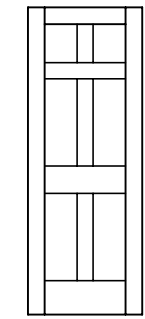

108FP 4108

PON, RAD, KPN,
PRM¹, OAK, MPL,
POP, CHY, KAL²,
FIR, RHK, MHG,
WAL

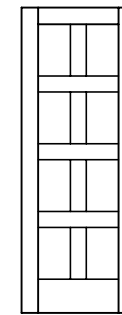

4109

PON, RAD, KPN,
PRM¹, OAK, MPL,
POP, CHY, KAL²,
FIR, RHK, MHG,
WAL

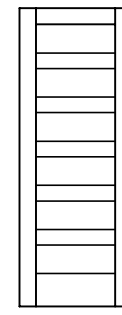

4112

PON, RAD, KPN,
PRM¹, OAK, MPL,
POP, CHY, KAL²,
FIR, RHK, MHG,
WAL

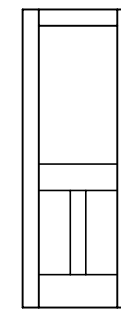

4129

PON, RAD, KPN,
PRM¹, OAK, MPL,
POP, CHY, KAL²,
FIR, RHK, MHG,
WAL

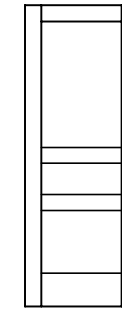

4131

PON, RAD, KPN,
PRM¹, OAK, MPL,
POP, CHY, KAL²,
FIR, RHK, MHG,
WAL

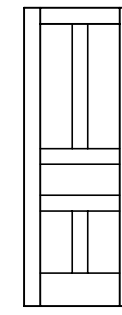

4133

PON, RAD, KPN,
PRM¹, OAK, MPL,
POP, CHY, KAL²,
FIR, RHK, MHG,
WAL

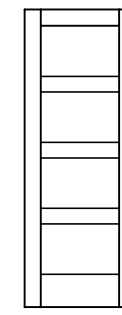

4141

PON, RAD, KPN,
PRM¹, OAK, MPL,
POP, CHY, KAL²,
FIR, RHK, MHG,
WAL

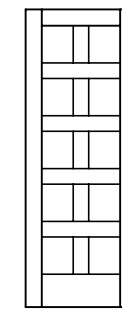

4158

PON, RAD, KPN,
PRM¹, OAK, MPL,
POP, CHY, KAL²,
FIR, RHK, MHG,
WAL

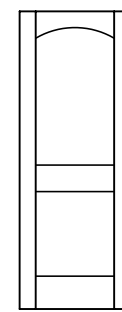

4802

PON, RAD, KPN,
PRM¹, OAK, MPL,
POP, CHY, KAL²,
FIR, RHK, MHG,
WAL

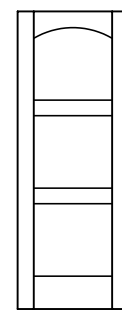

4803

PON, RAD, KPN,
PRM¹, OAK, MPL,
POP, CHY, KAL²,
FIR, RHK, MHG,
WAL



4831

PON, RAD, KPN,
PRM¹, OAK, MPL,
POP, CHY, KAL²,
FIR, RHK, MHG,
WAL

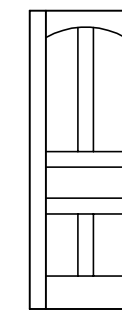

4833

PON, RAD, KPN,
PRM¹, OAK, MPL,
POP, CHY, KAL²,
FIR, RHK, MHG,
WAL

DRY ERASE AND MAGNETIC CHALKBOARD

Woodgrain Doors offers Dry Erase Whiteboard and Magnetic Chalkboard in the designs below:



20 FP
4020



102 FP
4102



For FIRE rated door information
See page 46

¹ Specie is manufactured with MDF skins and panels.

² Specie only available in Shaker Sticking (4000 Series).

INTERIOR PLANK PANEL DOORS

SPECIFICATIONS

- 6'8", 7'0" and 8'0" heights
- 1'0" to 3'0" widths
- 1-3/8" and 1-3/4" thicknesses
- Square and Arch Tops
- Taper Block Sticking
- Fire Rated (available on 1-3/4" only)

PANEL PROFILES

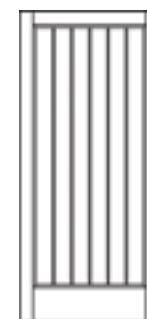
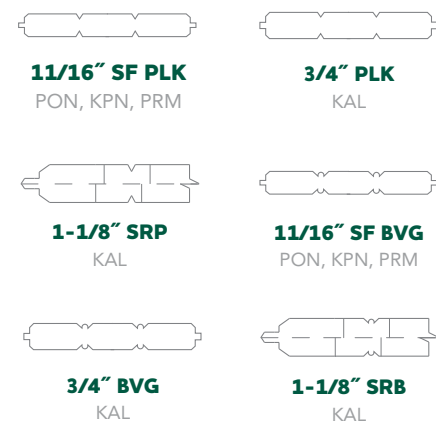

20 PLK
KAL



102 PLK
PON, KPN, PRM¹,
KAL



802 PLK
PON, KPN, PRM¹,
KAL

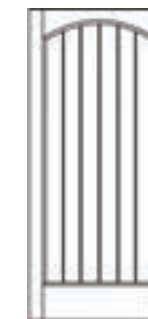

820 PLK
KAL

¹ Specie is Primed Pine unless otherwise noted.



For FIRE rated door information see [page 46](#)

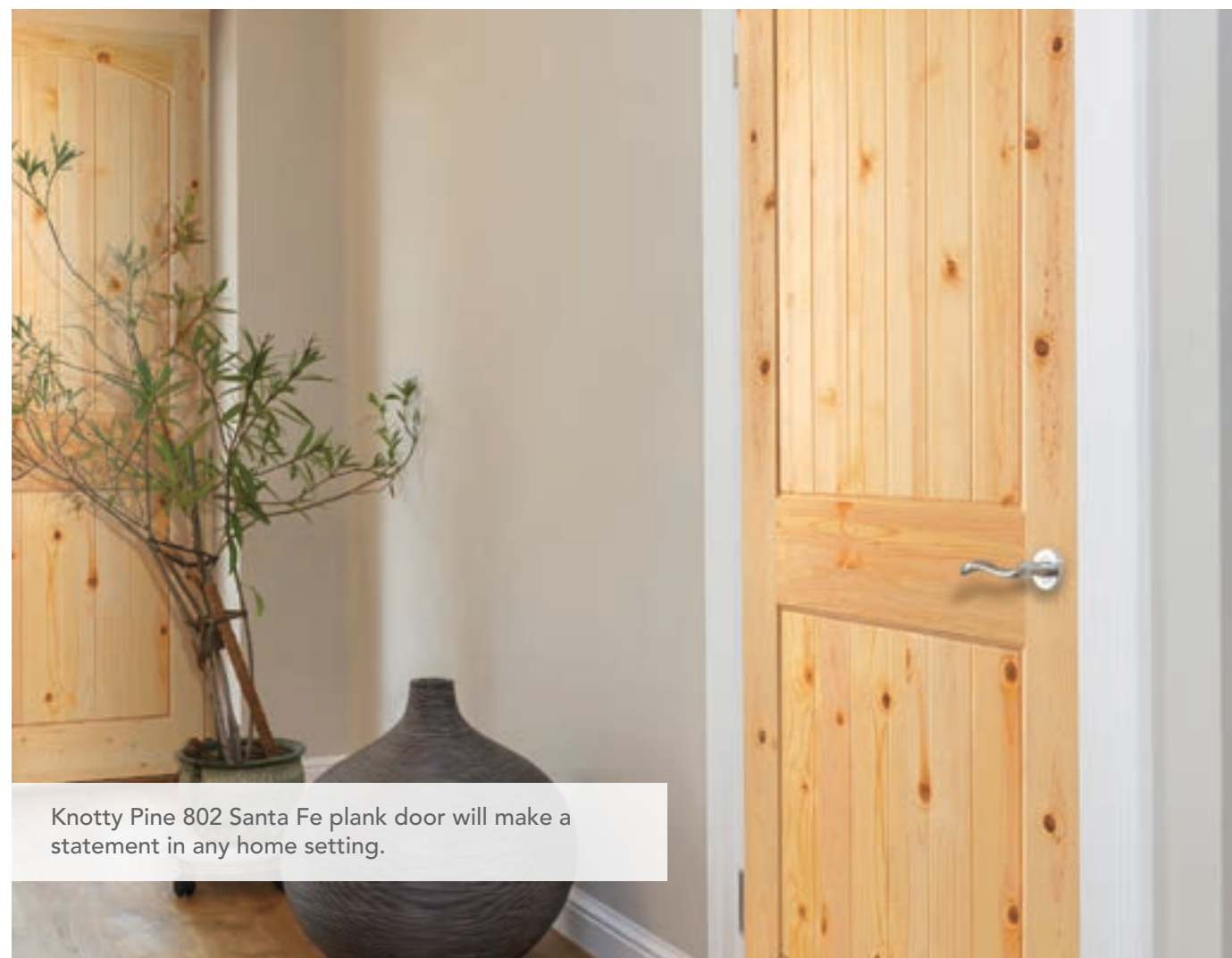

Knotty Pine 802 Santa Fe plank door will make a statement in any home setting.



INTERIOR BARN DOORS*

SPECIFICATIONS

- 6'8", 7'0" and 8'0" heights
- 2'0" to 4'0" widths
- 1-3/8" and 1-3/4" thicknesses

AVAILABLE MOUNTING HARDWARE

- 72", 84", and 96" tracks
- Rated up to 200 lbs.
- Handle options and connector piece available

TOP MOUNT



SHOWN IN BLACK FINISH

HANGING MOUNT



SHOWN IN BLACK FINISH

Both mounts also available in Nickel Finish

PANEL OPTIONS



3/4" PLK
PON, RAD, KPN,
PRM, KAL, FIR, RHK



SHAKER (4000 SERIES)
PON, RAD, KPN,
PRM, KAL, FIR, RHK



PLANK PANEL

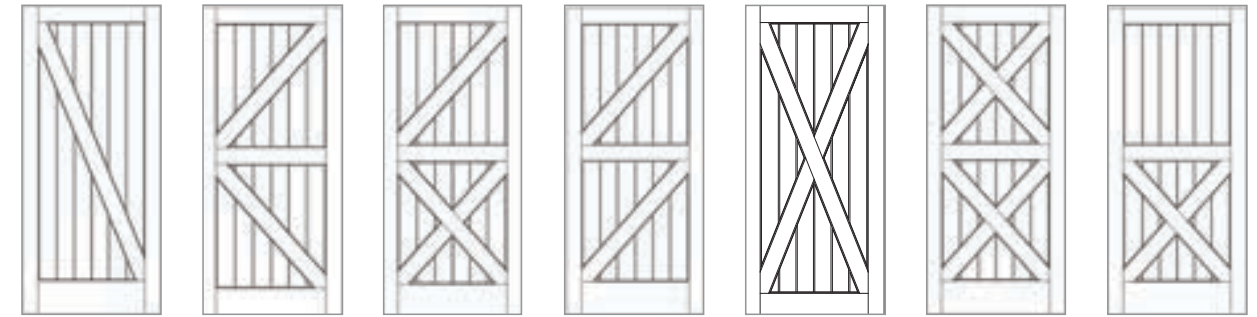

- 180** PON, RAD, KPN, PRM, KAL, FIR, RHK
- 181** PON, RAD, KPN, PRM, KAL, FIR, RHK
- 182** PON, RAD, KPN, PRM, KAL, FIR, RHK
- 183** PON, RAD, KPN, PRM, KAL, FIR, RHK
- 184** PON, RAD, KPN, PRM, KAL, FIR, RHK
- 185** PON, RAD, KPN, PRM, KAL, FIR, RHK
- 186** PON, RAD, KPN, PRM, KAL, FIR, RHK

SHAKER PANEL

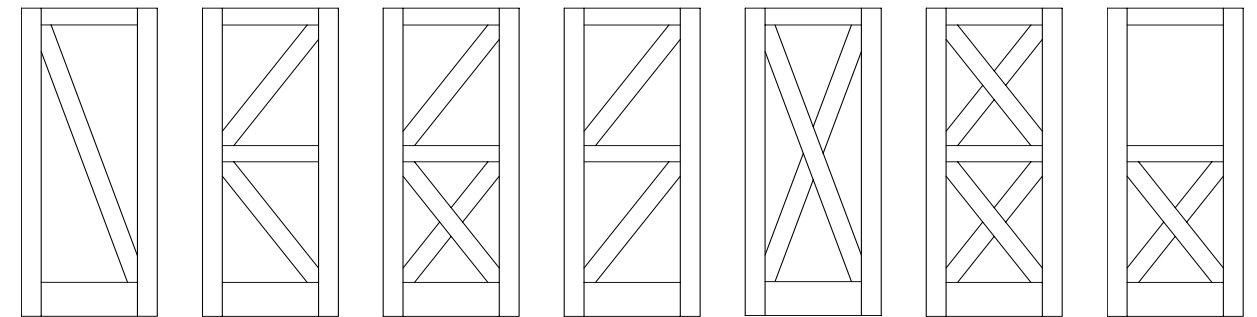

- 4180** PON, RAD, KPN, PRM, KAL, FIR, RHK
- 4181** PON, RAD, KPN, PRM, KAL, FIR, RHK
- 4182** PON, RAD, KPN, PRM, KAL, FIR, RHK
- 4183** PON, RAD, KPN, PRM, KAL, FIR, RHK
- 4184** PON, RAD, KPN, PRM, KAL, FIR, RHK
- 4185** PON, RAD, KPN, PRM, KAL, FIR, RHK
- 4186** PON, RAD, KPN, PRM, KAL, FIR, RHK

GLASS OPTIONS

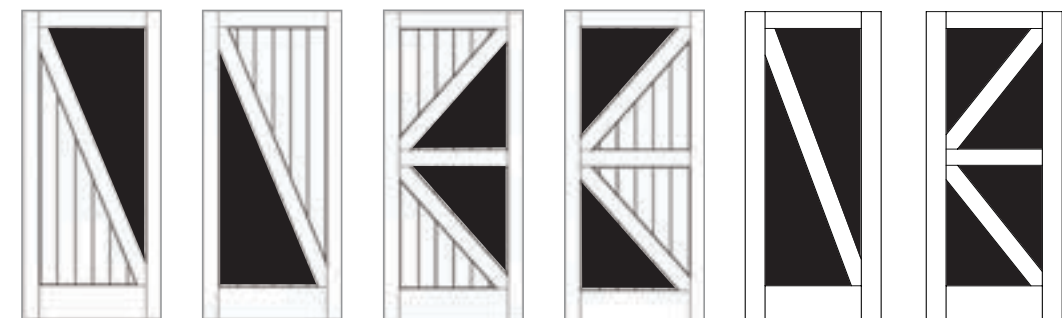

- 380 TOP** PON, RAD, KPN, PRM, KAL, FIR, RHK
- 380 BTM** PON, RAD, KPN, PRM, KAL, FIR, RHK
- 381 MID** PON, RAD, KPN, PRM, KAL, FIR, RHK
- 381 OUT** PON, RAD, KPN, PRM, KAL, FIR, RHK
- 4380** PON, RAD, KPN, PRM, KAL, FIR, RHK
- 4381** PON, RAD, KPN, PRM, KAL, FIR, RHK

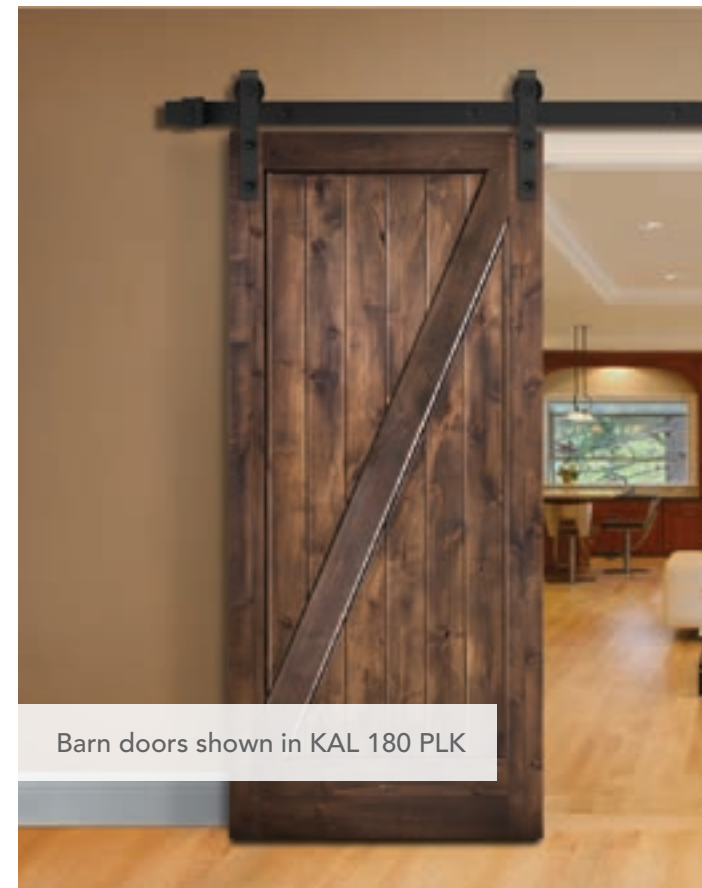

Barn doors shown in KAL 180 PLK



PRM 4020



PRM 20FP

***NOTE: ANY WOODGRAIN DOOR CAN BE USED IN BARN DOOR OR "ROLLING DOOR" APPLICATION**

INTERIOR LOUVER & CAFE DOORS

SPECIFICATIONS

- 6'8", 7'0" and 8'0" heights
- 1'0" to 3'0" widths
- 1-3/8" and 1-3/4" thicknesses
- "W" models available with 11" bottom rail for ADA compliance

PANEL OPTIONS

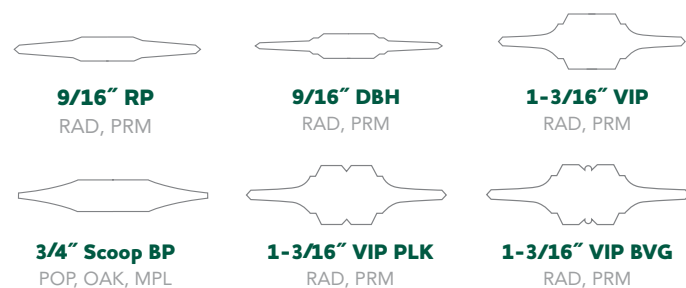

CAFÉ LOUVER



733 Café
RAD

SPECIFICATIONS

- 3'3" height
- 2'0" to 3'0" widths
- 1-1/8" thickness

STANDARD LOUVER

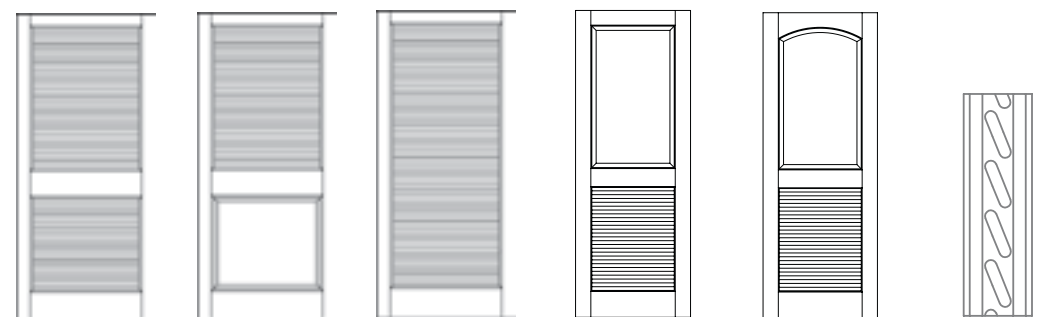

730
PON, RAD, PRM¹, OAK, MPL, POP, FIR, RHK

732
PON, RAD, PRM¹, OAK, MPL, POP, FIR, RHK

733
PON, RAD, PRM¹, FIR, RHK

742
PON, RAD, PRM¹, OAK, MPL, POP, FIR, RHK

782
PON, RAD, PRM¹, OAK, MPL, POP, FIR, RHK

1-3/16" Standard Louver

PLANTATION LOUVER



P 730
RAD, PRM¹, OAK, MPL, POP, FIR, RHK

P 732
RAD, PRM¹, OAK, MPL, POP, FIR, RHK

P 742
PON, RAD, PRM¹, OAK, MPL, POP, FIR, RHK

P 782
PON, RAD, PRM¹, OAK, MPL, POP, FIR, RHK

2-1/4" Plantation Louver

FALSE LOUVER

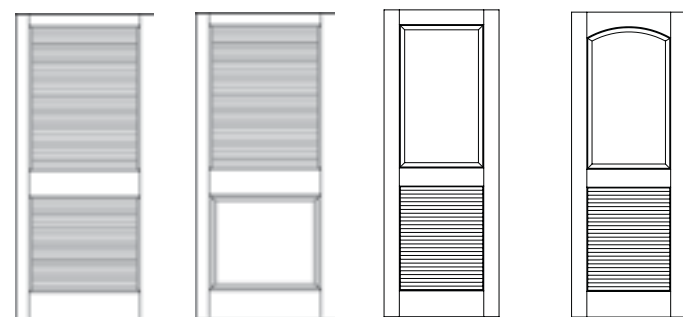

F 730
PON, RAD, PRM¹

F 732
PON, RAD, PRM¹

F 742
PON, RAD, PRM¹

F 782
PON, RAD, PRM¹

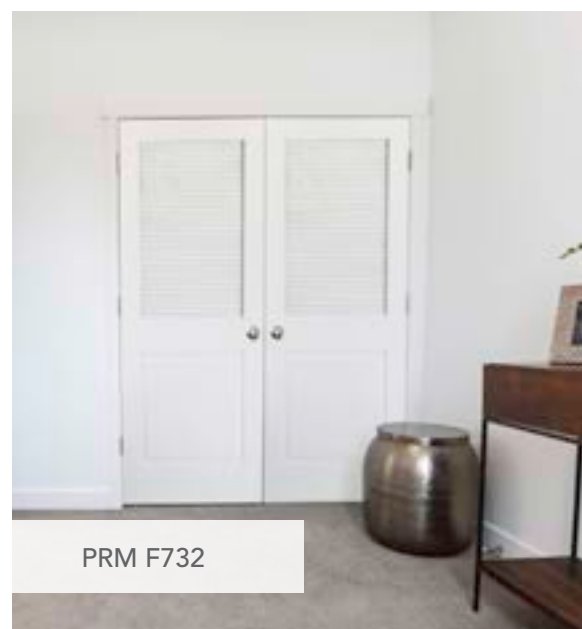

PLANTATION FALSE LOUVER

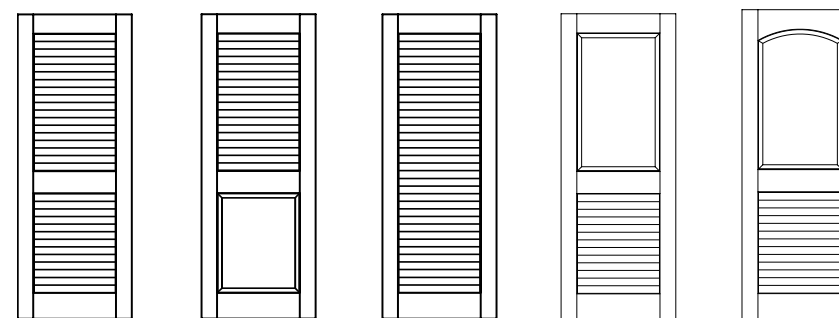

PF 730
PON, RAD, PRM¹

PF 732
PON, RAD, PRM¹

PF 733
PON, RAD, PRM¹

PF 742
PON, RAD, PRM¹

PF 782
PON, RAD, PRM¹

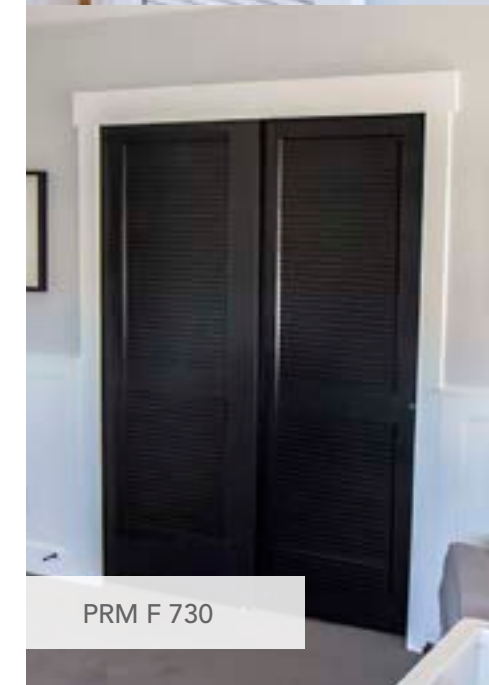
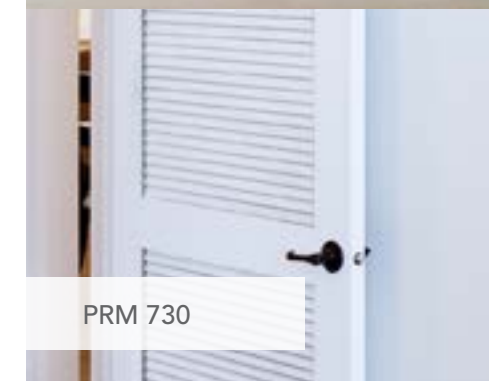

¹Specie is manufactured with MDF skins and panels.

INTERIOR BIFOLD DOORS

SPECIFICATIONS

- 6'8", 7'0" and 8'0" heights
- 2'0" to 6'0" widths
- 1-3/8" thicknesses
- Square and Arch Tops

PREMIUM: 1-3/8" thickness;
2-1/4" stiles with full scale rails

PREMIUM PANEL OPTIONS

9/16" RP PON, RAD, KPN, PRM	3/8" Flat PON, RAD, OAK, MPL, POP, CHY, KAL, FIR, RHK, MHG, WAL	9/16" DBH PON, RAD, KPN, PRM
11/16" SF PLK PON, RAD, KPN	3/4" PLK KAL	1-3/16" VIP PLK PON, RAD, KPN, FIR, RHK, MHG, WAL
3/4" Scoop BP OAK, POP, CHY, MPL	3/4" DBH KAL, FIR, RHK, MHG, WAL	1-3/16" VIP PON, RAD, KPN, FIR, RHK, MHG, WAL
11/16" SF BVG PON, RAD, KPN	3/4" BVG KAL	1-3/16" VIP BVG PON, RAD, KPN, FIR, RHK, MHG, WAL

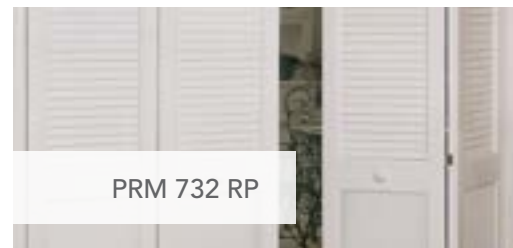

PRM 732 RP



PRM 106/102RP



RAD 4106/4102

PREMIUM SERIES

RAISED PANEL

100 PON, RAD, KPN, PRM ¹	103 PON, RAD, KPN, PRM ¹ , OAK, MPL, POP, CHY, KAL, FIR, RHK, MHG, WAL	106 PON, RAD, KPN, PRM ¹ , OAK, MPL, POP, CHY, KAL, FIR, RHK, MHG, WAL	107 PON, RAD, KPN, PRM ¹ , OAK, MPL, POP, CHY, KAL, FIR, RHK, MHG, WAL	730 PON, RAD, PRM ¹ , OAK, MPL, POP	732 PON, RAD, PRM ¹ , OAK, MPL, POP	733 PON, RAD, PRM ¹

108 PON, RAD, KPN, PRM ¹ , OAK, MPL, POP, CHY, KAL, FIR, RHK, MHG, WAL	109 PON, RAD, KPN, PRM ¹ , OAK, MPL, POP, CHY, KAL, FIR, RHK, MHG, WAL	802 PON, RAD, KPN, PRM ¹ , OAK, MPL, POP, CHY, KAL, FIR, RHK, MHG, WAL	822 PON, RAD, KPN, PRM ¹	P 730* RAD, PRM ¹ , OAK, MPL, POP	P 732* RAD, PRM ¹ , OAK, MPL, POP	P 733* RAD, PRM ¹ , OAK, MPL, POP

* 2-1/4" wide slat

PLANK PANEL

106 PON, KPN, KAL	802 PON, KPN, KAL	20 FP 4020 PON, RAD, KPN, PRM ¹ , OAK, MPL, POP, CHY, KAL ² , FIR, RHK, MHG, WAL	103 FP 4103 PON, RAD, KPN, PRM ¹ , OAK ² , MPL, POP, CHY, KAL ² , FIR, RHK, MHG, WAL	103T FP 4103T PON, RAD, KPN, PRM ¹ , OAK ² , MPL ² , POP ² , CHY ² , FIR, RHK, MHG, WAL	106 FP 4106 PON, RAD, KPN, PRM ¹ , OAK, MPL, POP, CHY, KAL ² , FIR, RHK, MHG, WAL	107 FP 4107 PON, RAD, KPN, PRM ¹ , OAK, MPL, POP, CHY, KAL ² , FIR, RHK, MHG, WAL

¹ Specie is manufactured with MDF skins and panels.

² Species only available in Shaker (400 Series).

INTERIOR

DECORATIVE GLASS AND UTILITY DOORS

SPECIFICATIONS

- 6'8", 7'0" and 8'0" heights
- 2'0" to 3'0" widths
- 1-3/8" and 1-3/4" thicknesses
- Clear V-Groove Single Glazed Glass
- Frosted Silk Screen Glass

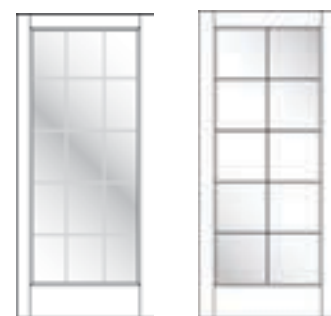

670
PON, RAD, KPN,
PRM, OAK, MPL,
POP, CHY, KAL,
FIR, RHK, MHG,
WAL

672
PON, RAD, KPN,
PRM, OAK, MPL,
POP, CHY, KAL,
FIR, RHK, MHG,
WAL

*Not all sizes are available in all options.

8'0" DOOR



All Decorative Glass Doors are available in 8'0" with wood panel options in all species.

8'0" DOOR

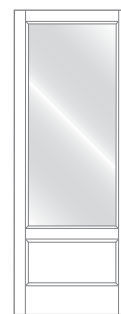

All Utility Doors are available in 8'0" with wood panel options in all species.



650
PON, RAD, KPN,
PRM, OAK, MPL,
POP, CHY, KAL,
FIR, RHK, MHG,
WAL

652
PON, RAD, KPN,
PRM, OAK, MPL,
POP, CHY, KAL,
FIR, RHK, MHG,
WAL

653
PON, RAD, KPN,
PRM, OAK, MPL,
POP, CHY, KAL,
FIR, RHK, MHG,
WAL



650 Laundry



652 Pantry



653 Wine Cellar



INTERIOR FRENCH DOORS

SPECIFICATIONS

- 6'8", 7'0" and 8'0" heights
- 1'6" to 3'0" widths
- 1-3/8" and 1-3/4" thicknesses
- Square, Arch and Eyebrow Tops
- Single Glazed Glass
- See page 14 and 15 for Glass Options

STICKING OPTIONS

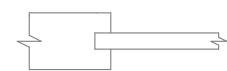

SHAKER (4000 SERIES)
AVAILABLE IN ALL WOOD SPECIES

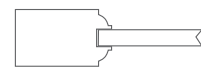

Ovolo / 600 Series
AVAILABLE IN ALL WOOD SPECIES

CONTEMPORARY

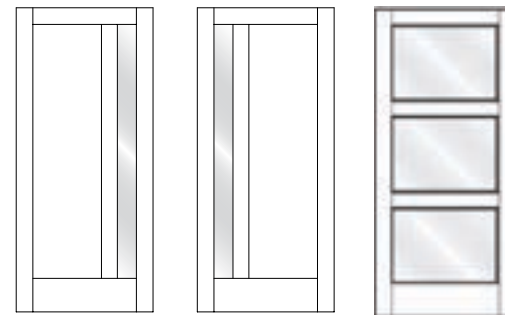

4517 PON, RAD, KPN, PRM, OAK, MPL, POP, CHY, KAL, FIR, RHK, MHG, WAL
4517A PON, RAD, KPN, PRM, OAK, MPL, POP, CHY, KAL, FIR, RHK, MHG, WAL
603 / 4603 PON, RAD, KPN, PRM, OAK, MPL, POP, CHY, KAL, FIR, RHK, MHG, WAL

TRADITIONAL



624 PON, RAD, KPN, PRM, OAK, MPL, POP, CHY, KAL, FIR, RHK, MHG, WAL
625 PON, RAD, KPN, PRM, OAK, MPL, POP, CHY, KAL, FIR, RHK, MHG, WAL
626 PON, RAD, KPN, PRM, OAK, MPL, POP, CHY, KAL, FIR, RHK, MHG, WAL
627 PON, RAD, KPN, PRM, OAK, MPL, POP, CHY, KAL, FIR, RHK, MHG, WAL
628 PON, RAD, KPN, PRM, OAK, MPL, POP, CHY, KAL, FIR, RHK, MHG, WAL
630 PON, RAD, KPN, PRM, OAK, MPL, POP, CHY, KAL, FIR, RHK, MHG, WAL
633 PON, RAD, KPN, PRM, OAK, MPL, POP, CHY, KAL, FIR, RHK, MHG, WAL



603W / 4603W PON, RAD, KPN, PRM, OAK, MPL, POP, CHY, KAL, FIR, RHK, MHG, WAL
604 / 4604 PON, RAD, KPN, PRM, OAK, MPL, POP, CHY, KAL, FIR, RHK, MHG, WAL
604W / 4604W PON, RAD, KPN, PRM, OAK, MPL, POP, CHY, KAL, FIR, RHK, MHG, WAL
605 / 4605 PON, RAD, KPN, PRM, OAK, MPL, POP, CHY, KAL, FIR, RHK, MHG, WAL
605W / 4605W PON, RAD, KPN, PRM, OAK, MPL, POP, CHY, KAL, FIR, RHK, MHG, WAL
606W / 4606W PON, RAD, KPN, PRM, OAK, MPL, POP, CHY, KAL, FIR, RHK, MHG, WAL
607W / 4607W PON, RAD, KPN, PRM, OAK, MPL, POP, CHY, KAL, FIR, RHK, MHG, WAL

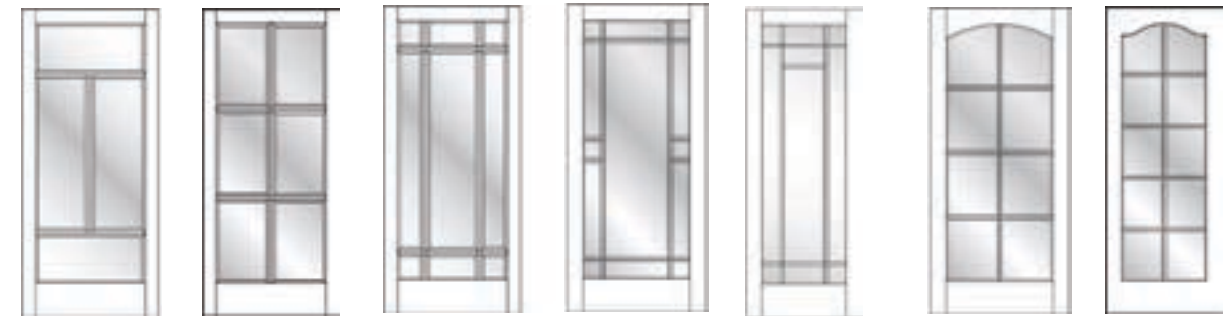

634 PON, RAD, KPN, PRM, OAK, MPL, POP, CHY
636 PON, RAD, KPN, PRM, OAK, MPL, POP, CHY, KAL, FIR, RHK, MHG, WAL
690 PON, RAD, KPN, PRM, OAK, MPL, POP, CHY, KAL, FIR, RHK, MHG, WAL
691 PON, RAD, KPN, PRM, OAK, MPL, POP, CHY, FIR, RHK, MHG, WAL
692 PON, RAD, KPN, PRM, OAK, MPL, POP, CHY, FIR, RHK, MHG, WAL
824 PON, RAD, KPN, PRM, OAK, MPL, POP, CHY, KAL, FIR, RHK, MHG, WAL
825 PON, RAD, KPN, PRM, OAK, MPL, POP, CHY, KAL, FIR, RHK, MHG, WAL

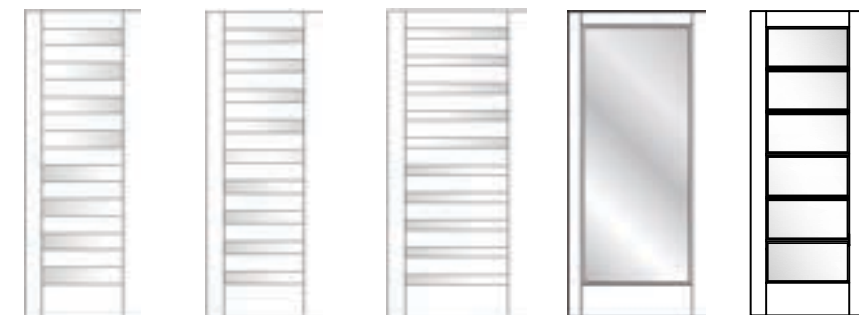

608 / 4608 PON, RAD, KPN, PRM, OAK, MPL, POP, CHY, KAL, FIR, RHK, MHG, WAL
609 / 4609 PON, RAD, KPN, PRM, OAK, MPL, POP, CHY, KAL, FIR, RHK, MHG, WAL
610 / 4610 PON, RAD, KPN, PRM, OAK, MPL, POP, CHY, KAL, FIR, RHK, MHG, WAL
620 PON, RAD, KPN, PRM, OAK, MPL, POP, CHY, KAL, FIR, RHK, MHG, WAL
622 PON, RAD, KPN, PRM, OAK, MPL, POP, CHY, KAL, FIR, RHK, MHG, WAL

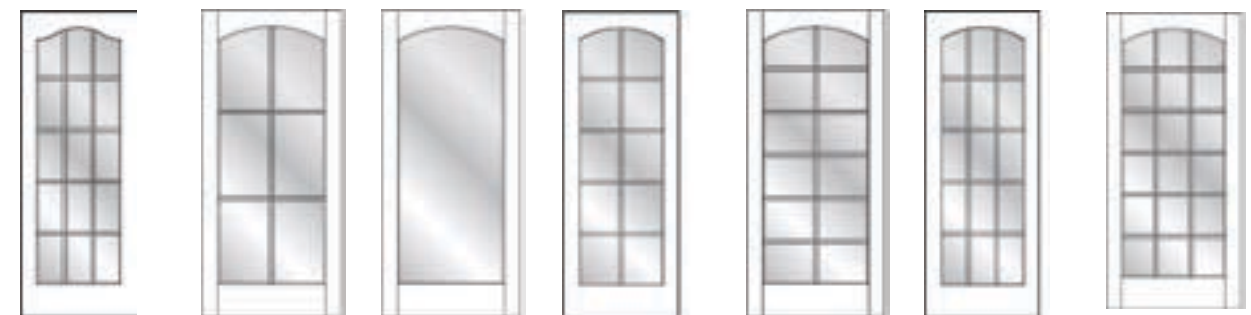

827 PON, RAD, KPN, PRM, OAK, MPL, POP, CHY, KAL, FIR, RHK, MHG, WAL
836 PON, RAD, KPN, PRM, OAK, MPL, POP, CHY, KAL, FIR, RHK, MHG, WAL
840 PON, RAD, KPN, PRM, OAK, MPL, POP, CHY, KAL, FIR, RHK, MHG, WAL
845 PON, RAD, KPN, PRM, OAK, MPL, POP, CHY, KAL, FIR, RHK, MHG, WAL
846 PON, RAD, KPN, PRM, OAK, MPL, POP, CHY, KAL, FIR, RHK, MHG, WAL
847 PON, RAD, KPN, PRM, OAK, MPL, POP, CHY, KAL, FIR, RHK, MHG, WAL
848 PON, RAD, KPN, PRM, OAK, MPL, POP, CHY, KAL, FIR, RHK, MHG, WAL

¹Species only available in 1-3/8" thickness.

INTERIOR SASH DOORS

PANEL OPTIONS

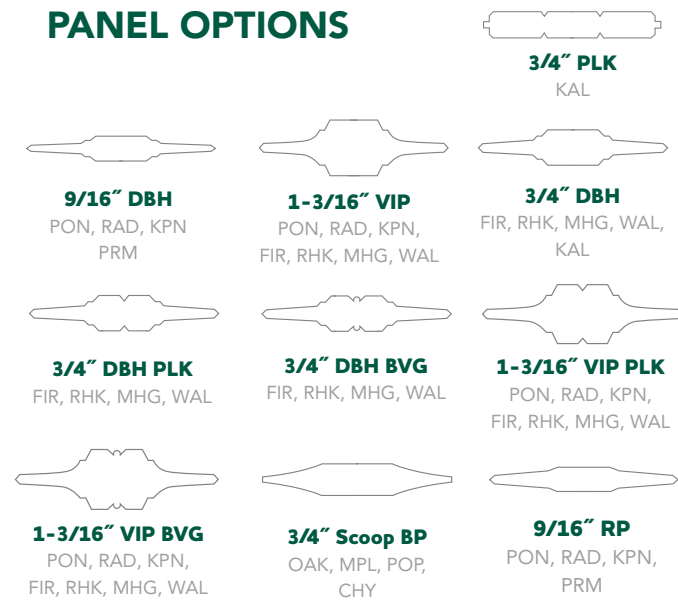

511 PON, RAD, KPN, PRM, OAK, MPL, POP, CHY, KAL
512 PON, RAD, KPN, PRM, OAK, MPL, POP, CHY, KAL
513 PON, RAD, KPN, PRM, OAK, MPL, POP, CHY, KAL

SPECIFICATIONS

- 6'8", 7'0" and 8'0" heights
- 2'0" to 3'0" widths
- 1-3/8" and 1-3/4" thicknesses
- Square, Arch and Eyebrow Tops
- Single Glazed Glass

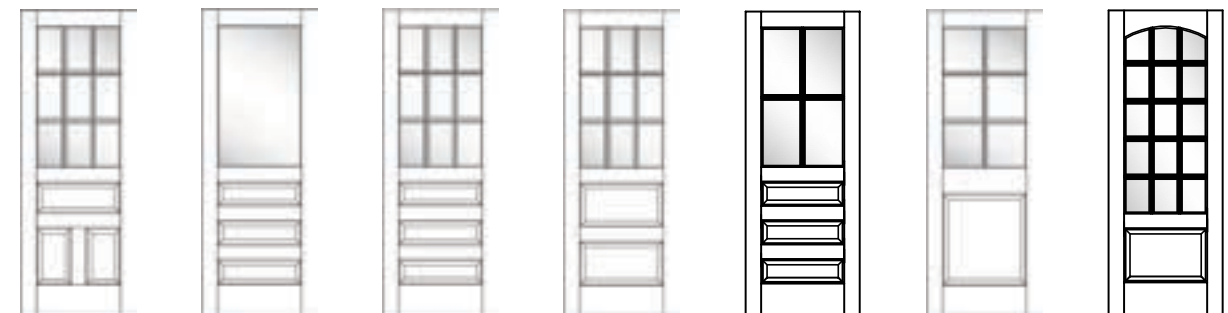

570 PON, RAD, KPN, PRM¹, FIR, RHK, MHG, WAL
571 PON, RAD, KPN, PRM¹, FIR, RHK, MHG, WAL
572 PON, RAD, KPN, PRM¹, FIR, RHK, MHG, WAL
573 PON, RAD, KPN, PRM¹, FIR, RHK, MHG, WAL
574 PON, RAD, KPN, PRM¹, FIR, RHK, MHG, WAL
581 PON, RAD, KPN, PRM¹, FIR, RHK, MHG, WAL
811 PON, RAD, KPN, PRM¹, OAK, MPL, POP, CHY, KAL



514 PON, RAD, KPN, PRM, OAK, MPL, POP, CHY, KAL
515 PON, RAD, KPN, PRM, OAK, MPL, POP, CHY, KAL
516 PON, RAD, KPN, PRM, OAK, MPL, POP, CHY, KAL
518 PON, RAD, KPN, PRM, OAK, MPL, POP, CHY, KAL
519 PON, RAD, KPN, PRM, OAK, MPL, POP, CHY, KAL
551 PON, RAD, KPN, PRM, OAK, MPL, POP, CHY, KAL, FIR, RHK, MHG, WAL
558 PON, RAD, KPN, PRM, FIR, RHK, MHG, WAL



812 PON, RAD, KPN, PRM¹, OAK, MPL, POP, CHY, KAL
813 PON, RAD, KPN, PRM¹, OAK, MPL, POP, CHY, KAL
814 PON, RAD, KPN, PRM¹, OAK, MPL, POP, CHY, KAL
816 PON, RAD, KPN, PRM¹, OAK, MPL, POP, CHY, KAL
818 PON, RAD, KPN, PRM¹, OAK, MPL, POP, CHY, KAL
819 PON, RAD, KPN, PRM¹, OAK, MPL, POP, CHY, KAL
844 PON, RAD, KPN, PRM¹, OAK, MPL, POP, CHY, KAL



559 PON, RAD, KPN, PRM¹, OAK, MPL, POP, CHY, KAL, FIR, RHK, MHG, WAL
560 PON, RAD, KPN, PRM¹, OAK, MPL, POP, CHY, KAL, FIR, RHK, MHG, WAL
561 PON, RAD, KPN, PRM¹, OAK, MPL, POP, CHY, KAL, FIR, RHK, MHG, WAL
562 PON, RAD, KPN, PRM¹, OAK, MPL, POP, CHY, KAL, FIR, RHK, MHG, WAL
563 PON, RAD, KPN, PRM¹, FIR, RHK, MHG, WAL
564 PON, RAD, KPN, PRM¹, FIR, RHK, MHG, WAL
567 PON, RAD, KPN, PRM¹, FIR, RHK, MHG, WAL

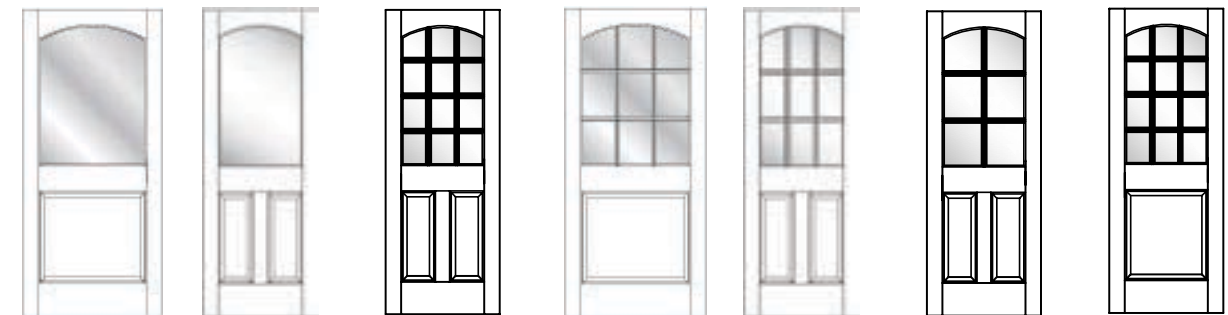

851 PON, RAD, KPN, PRM¹, OAK, MPL, POP, CHY, KAL, FIR, RHK, MHG, WAL
859 PON, RAD, KPN, PRM¹, OAK, MPL, POP, CHY, KAL, FIR, RHK, MHG, WAL
860 PON, RAD, KPN, PRM¹, OAK, MPL, POP, CHY, KAL, FIR, RHK, MHG, WAL
861 PON, RAD, KPN, PRM¹, OAK, MPL, POP, CHY, KAL, FIR, RHK, MHG, WAL
862 PON, RAD, KPN, PRM¹, OAK, MPL, POP, CHY, KAL, FIR, RHK, MHG, WAL
863 PON, RAD, KPN, PRM¹, OAK, MPL, POP, CHY, KAL, FIR, RHK, MHG, WAL
864 PON, RAD, KPN, PRM¹, OAK, MPL, POP, CHY, KAL, FIR, RHK, MHG, WAL

¹ Specie is manufactured with MDF skins and panels.

DESIGN COLLECTION PRIMED MDF DOORS

PREMIUM ROUTER CARVED MDF DOORS

Woodgrain's Design Collection MDF Doors are made of medium density fiberboard (MDF) and include both 1-3/8" and 1-3/4" doors available in panel, bifold and fire-rated doors. Design Collection MDF doors offer infinite design options by combining cutting edge technology and quality craftsmanship. Not simply an MDF producer, Woodgrain uses its well-honed techniques from decades of wood door manufacturing to build a better door.

DESIGN COLLECTION MDF DOORS OFFER:

- Exceptionally smooth surface for excellent paint adhesion
- Unlimited design options, including most graphics and text
- Resists shrinkage, expansion or warping
- Environmentally friendly
- SureEdge design

DESIGN COLLECTION MDF DOORS WITH EXPANDED POLYSTYRENE (EPS) CORE OFFER SEVERAL ADVANTAGES:

- 40% lighter than the standard 2'6" x 6'8" MDF door
- Easier to handle and hang
- Exerts less stress on the hinges
- Improve sound transmission properties
- Bifold doors available

 For FIRE rated door information see [page 46](#)

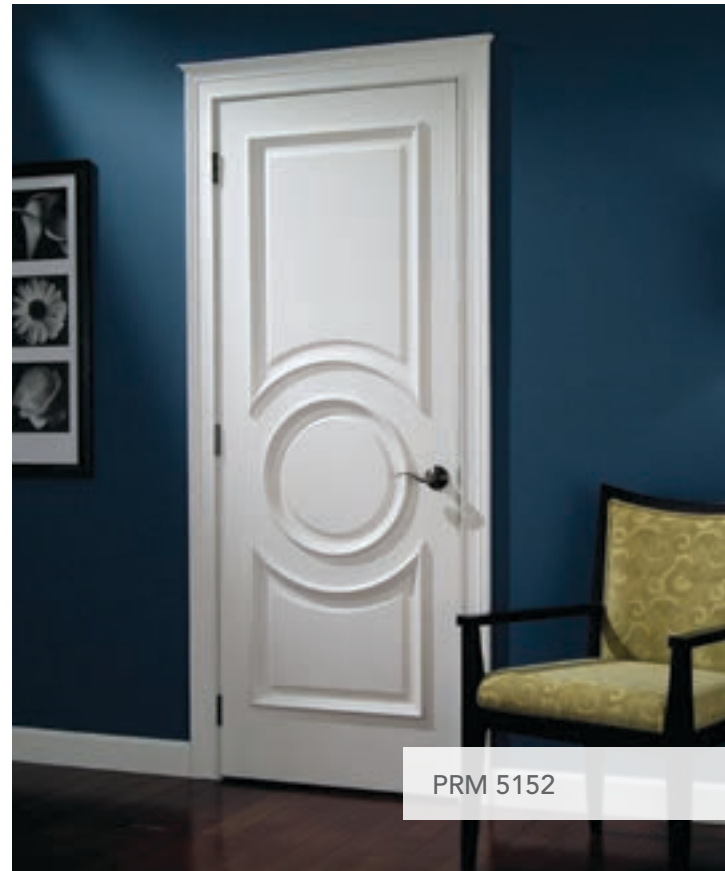

PRM 5152



PRM 5107

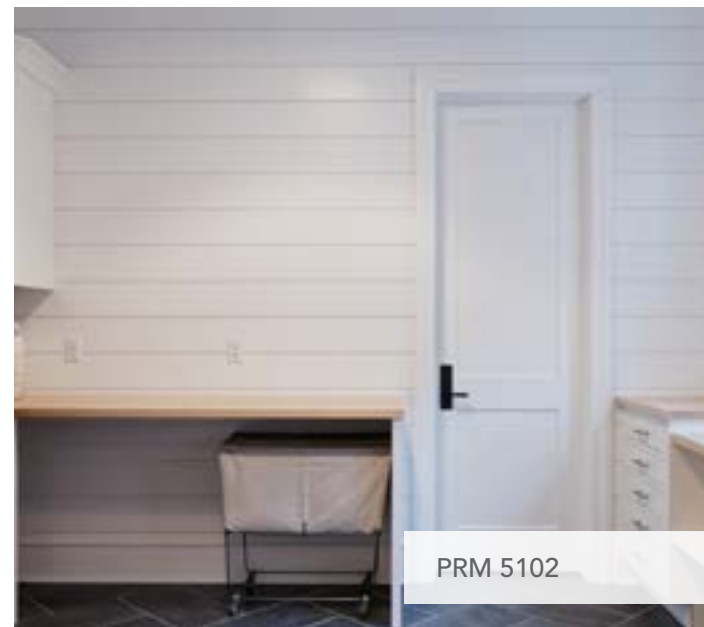

PRM 5102

PROFILE AND PANEL OPTIONS

Mix and match any of our five profile options or two raised moulding options.

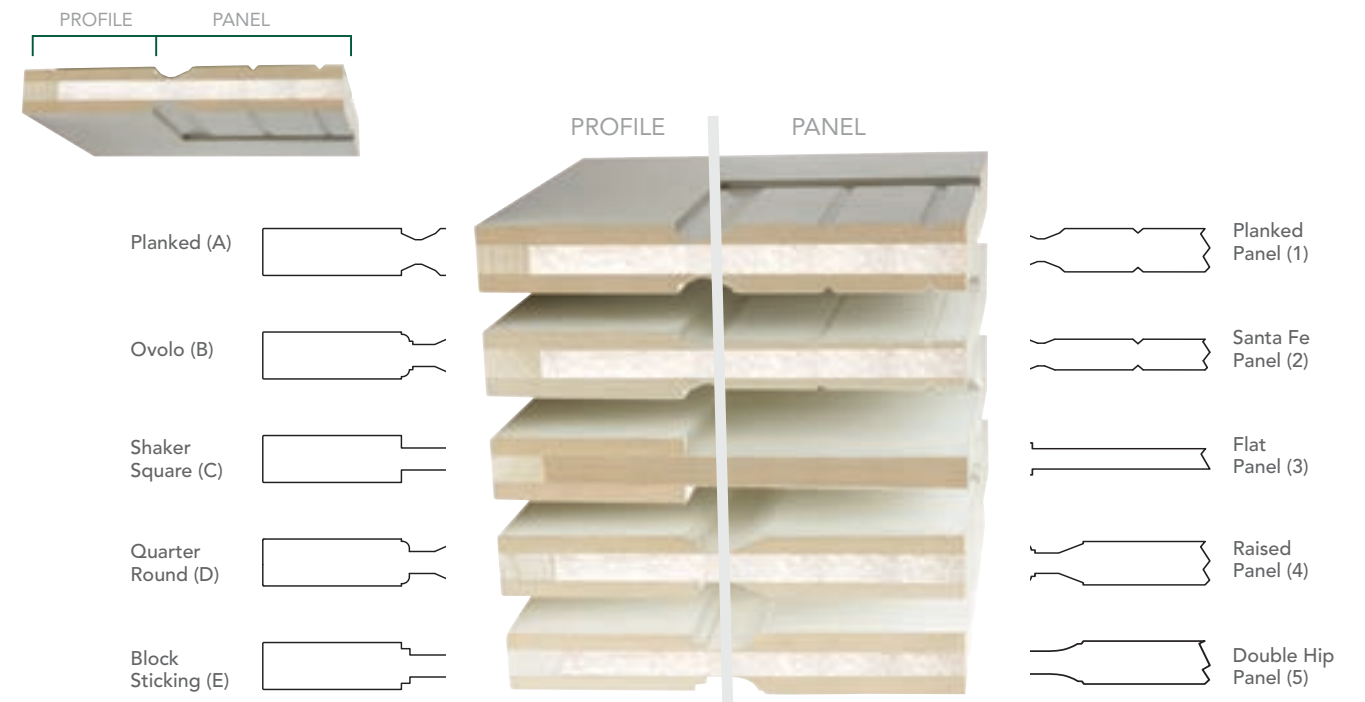

RAISED MOULDING

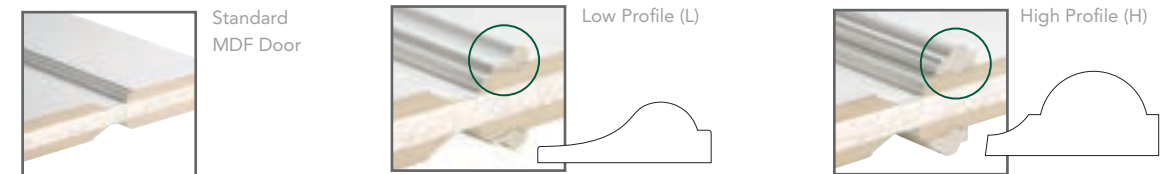

THE SUREEDGE ADVANTAGE:

SureEdge solid wood edge band is a feature in each MDF door. Installed in each stile the SureEdge system allows maximum screw holding power and ease of hinge mortising.

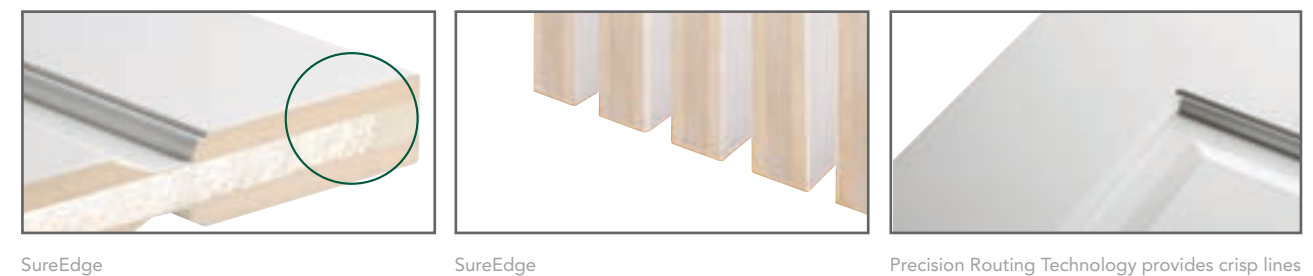

SureEdge

SureEdge

Precision Routing Technology provides crisp lines

INTERIOR

DESIGN COLLECTION PRIMED MDF DOORS

SPECIFICATIONS

- 6'8", 7'0", 7'6" and 8'0" heights
- 1'6" to 4'0" widths
- 1-3/8" and 1-3/4" thicknesses
- Fire Rated (available on 1-3/4" only)



5012
PRM



5013
PRM



5014
PRM



5015
PRM



5016
PRM



5019
PRM



5020
PRM



5122
PRM



5123
PRM



5124
PRM



5125
PRM



5126
PRM



5127
PRM



5129
PRM



5021
PRM



5022
PRM



5102
PRM



5103
PRM



5105
PRM



5106
PRM



5107
PRM



5130
PRM



5131
PRM



5132
PRM



5133
PRM



5135
PRM



5137
PRM



5138
PRM



5108
PRM



5109
PRM



5114
PRM



5115
PRM



5117
PRM



5118
PRM



5121
PRM



5139
PRM



5140
PRM



5141
PRM



5142
PRM



5143
PRM



5144
PRM



5145
PRM

INTERIOR

DESIGN COLLECTION PRIMED MDF DOORS

SPECIFICATIONS

- 6'8", 7'0", 7'6" and 8'0" heights
- 1'6" to 4'0" widths
- 1-3/8" and 1-3/4" thicknesses
- Fire Rated (available on 1-3/4" only)



5146
PRM



5147
PRM



5150
PRM



5152
PRM



5153
PRM



5154
PRM



5155
PRM



5503
PRM



5506
PRM



5509
PRM



5512
PRM



5517
PRM



5520
PRM



5521
PRM



5157
PRM



5158
PRM



5159
PRM



5161
PRM



5162
PRM



5166
PRM



5168
PRM



5529
PRM



5531
PRM



5548
PRM



5552
PRM



5553
PRM



5554
PRM



5555
PRM



5170
PRM



5172
PRM



5173
PRM



5255
PRM



5256
PRM



5257
PRM



5502
PRM



5570
PRM



5702
PRM



5706
PRM



5712
PRM



5720
PRM



5721
PRM



5726
PRM

INTERIOR

DESIGN COLLECTION PRIMED MDF DOORS

SPECIFICATIONS

- 6'8", 7'0", 7'6" and 8'0" heights
- 1'6" to 4'0" widths
- 1-3/8" and 1-3/4" thicknesses
- Fire Rated (available on 1-3/4" only)



5727
PRM



5728
PRM



5729
PRM



5730
PRM



5731
PRM



5732
PRM



5733
PRM



5778
PRM



5802
PRM



5803
PRM



5806
PRM



5808
PRM



5812
PRM



5818
PRM



5734
PRM



5738
PRM



5743
PRM



5754
PRM



5755
PRM



5768
PRM



5769
PRM



5819
PRM



5820
PRM



5821
PRM



5822
PRM



5823
PRM



5824
PRM



5825
PRM



5770
PRM



5772
PRM



5773
PRM



5774
PRM



5775
PRM



5776
PRM



5777
PRM



5826
PRM



5828
PRM



5829
PRM



5830
PRM



5831
PRM



5832
PRM



5833
PRM

INTERIOR

DESIGN COLLECTION PRIMED MDF DOORS

SPECIFICATIONS

- 6'8", 7'0", 7'6" and 8'0" heights
- 1'6" to 4'0" widths
- 1-3/8" and 1-3/4" thicknesses
- Fire Rated (available on 1-3/4" only)



5834
PRM



5835
PRM



5838
PRM



5839
PRM



5840
PRM



5843
PRM



5847
PRM



5876
PRM



5877
PRM



5878
PRM



5879
PRM



5920
PRM



5180
PRM



5181
PRM



5848
PRM



5849
PRM



5851
PRM



5852
PRM



5853
PRM



5854
PRM



5855
PRM



5182
PRM



5183
PRM



5184
PRM



5185
PRM



5186
PRM



5867
PRM



5868
PRM



5870
PRM



5872
PRM



5873
PRM



5874
PRM



5875
PRM

INTERIOR/EXTERIOR DUTCH DOORS

THE PROCESS

Our Dutch Door collections pays homage to the novel and practical split Dutch door style. The Dutch door designs allow the user to open the top of the door to allow light, air and the outside elements fill a room without having to open the entire door. The bottom half of the door can stay closed to allow privacy and ground, dust, and dirt to enter your home. Along with being super practical, the architectural design is elegant and completes the look of any room.

We offer a large selection of Dutch door styles that are designed and manufactured to be cut in half. All Woodgrain doors are shipped as a full slab, however, we do not ship the door pre-cut. The door shop or door hanger would make the needed cuts to finish the Dutch door functionality. There are a number of different cuts that would achieve the look each individual can determine what works best for their needs.



AVAILABLE PROFILES

PANEL PROFILES		SASH PROFILES	
100	19, 51	551	34, 55
102	19, 21, 23, 47, 51	559	34, 55
106	19, 21, 51	560	34
108	19, 51	561	34, 55
110	19	562	34, 55
129	19	563	34, 55
802	19, 23, 47, 51	564	34
804	19, 51	581	35, 55
806	19, 51	596	55
822	19, 51	598	56
842	19	612	56
4102	21		
4106	21		
4108	21		
4129	21		
4802	21		
		615	56
		851	35, 56
		859	35, 56
		860	35
		862	35, 56
		863	35
		864	35
		4551	
		4559	
		4851	
		4859	
		X551	
		6551	55
		6559	55
		6560	
		6561	55
		6562	55
		6563	55
		6564	
		6581	55
		6596	55
		6598	56
		6612	56
		6615	56
		6851	56
		6859	56
		6860	
		6861	56
		6862	56
		6863	
		6864	

SELECT PANEL OPTIONS

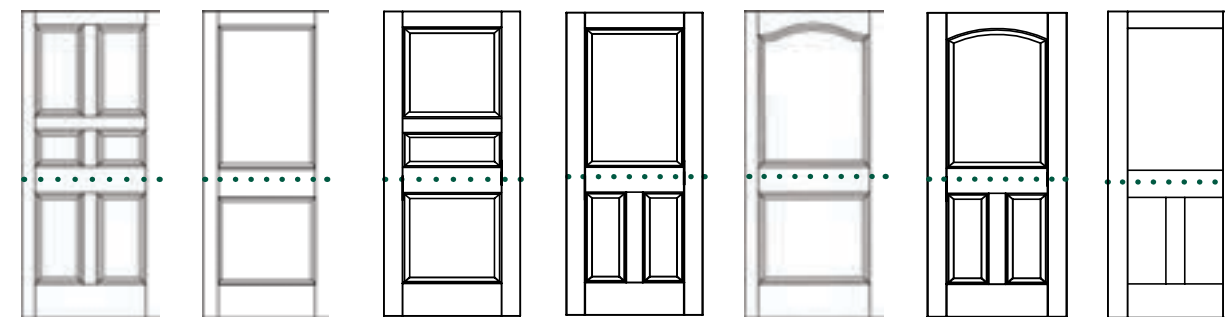

- 100**
PON, RAD, KPN, PRM¹, OAK, MPL, POP, CHY
- 102**
PON, RAD, KPN, PRM¹, OAK, MPL, POP, CHY, KAL, FIR, RHK, MHG, WAL
- 110**
PON, RAD, KPN, PRM¹, OAK, MPL, POP, CHY, KAL, FIR, RHK, MHG, WAL
- 129**
PON, RAD, KPN, PRM¹, OAK, MPL, POP, CHY, KAL, FIR, RHK, MHG, WAL
- 822**
PON, RAD, KPN, PRM¹
- 842**
PON, RAD, KPN, PRM¹, OAK, MPL, POP, CHY, KAL, FIR, RHK, MHG, WAL
- 4129**
PON, RAD, KPN, PRM¹, OAK, MPL, POP, CHY, KAL², FIR, RHK, MHG, WAL

SELECT SASH OPTIONS

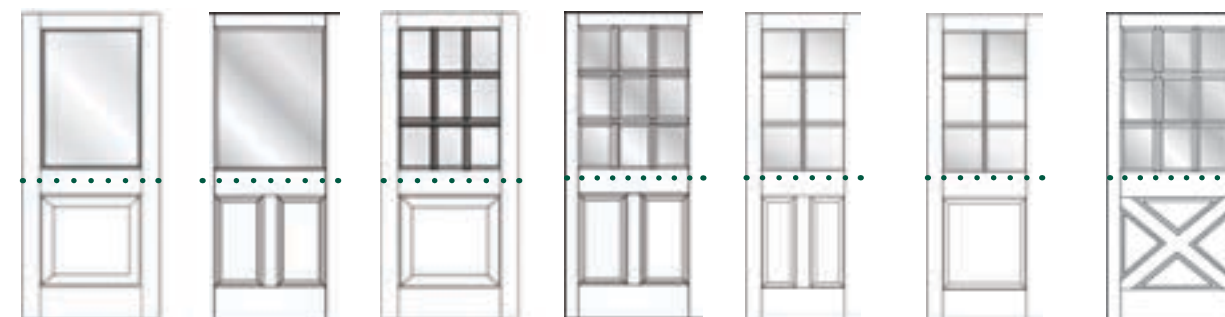

- 551 / 6551**
PON, RAD, KPN, PRM¹, KAL, FIR, RHK, MHG, WAL
- 559 / 6559**
PON, RAD, KPN, PRM¹, KAL, FIR, RHK, MHG, WAL
- 561 / 6561**
PON, RAD, KPN, PRM¹, KAL, FIR, RHK, MHG, WAL
- 562 / 6562**
PON, RAD, KPN, PRM¹, KAL, FIR, RHK, MHG, WAL
- 563 / 6563**
PON, RAD, KPN, PRM¹, FIR, RHK, MHG, WAL
- 581 / 6581**
PON, RAD, KPN, PRM¹ FIR, RHK, MHG, WAL, KAL
- 612**
RAD, FIR, RHK, MHG, WAL

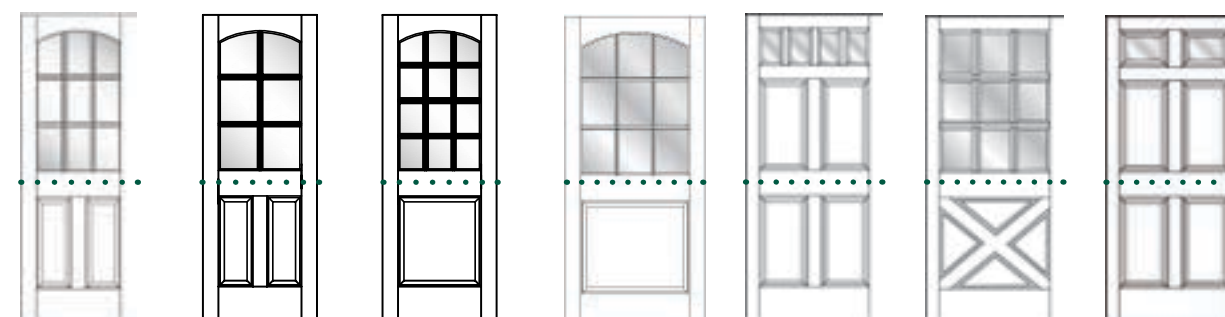

- 862**
PON, RAD, KPN, PRM¹, OAK, MPL, POP, CHY, KAL, FIR, RHK, MHG, WAL
- 863**
PON, RAD, KPN, PRM¹, OAK, MPL, POP, CHY, KAL, FIR, RHK, MHG, WAL
- 864**
PON, RAD, KPN, PRM¹, OAK, MPL, POP, CHY, KAL, FIR, RHK, MHG, WAL
- 861 / 6861**
PON, RAD, KPN, PRM¹, KAL, FIR, RHK, MHG, WAL
- 598 / 6598**
PON, RAD, KPN, PRM¹, FIR, RHK, MHG, WAL
- 6612**
PON, RAD, PRM¹, FIR, RHK, MHG, WAL
- 6864**
PON, RAD, KPN, PRM¹, FIR, RHK, MHG, WAL

FIRE RATED DOORS

FIRE RATED DOORS SPECIFICATIONS



20, 60 AND 90 MINUTE FIRE DOORS AVAILABLE FROM WOODGRAIN

Woodgrain doors manufactures 20, 60 and 90 minute fire rated doors in 14 different species. We achieve these ratings by incorporating a special intumescent core into our 1-3/4" thick doors.

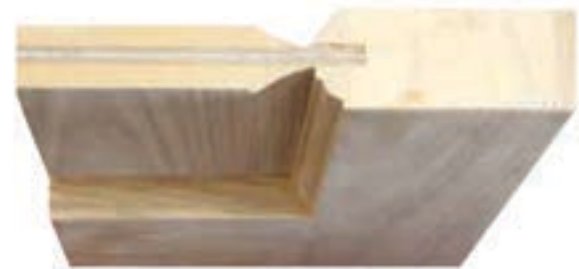
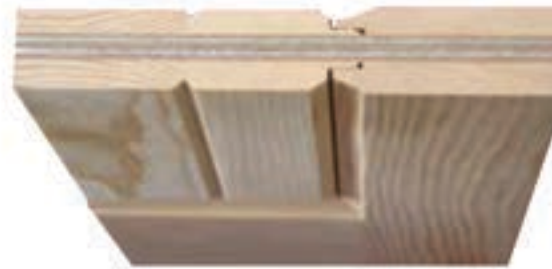

WOODGRAIN 20 MINUTE FIRE RATED DOOR

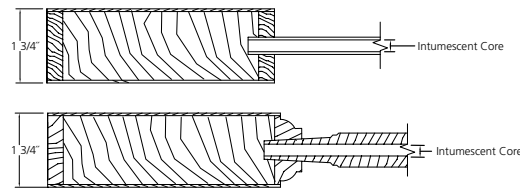

WOODGRAIN 90 MINUTE FIRE RATED WOOD DOOR

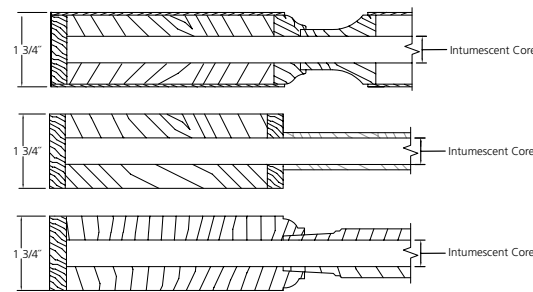

WOODGRAIN 60 MINUTE FIRE RATED DOOR

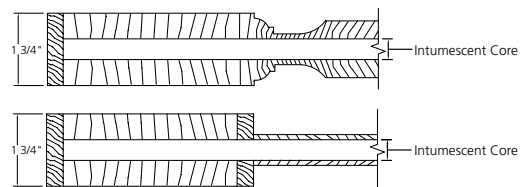

WOODGRAIN 90 MINUTE FIRE RATED MDF DOOR

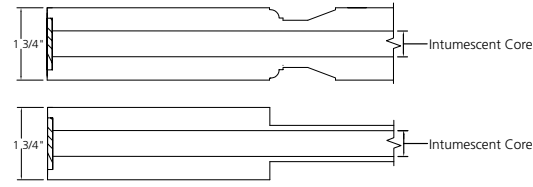

EXTERIOR

PLANK PANEL DOORS

SPECIFICATIONS

- 6'8", 7'0" and 8'0" heights
- 2'0" to 3'0" widths
- 1-3/4" thicknesses
- Square and Arch Tops
- Fire Rated Available

PANEL OPTIONS

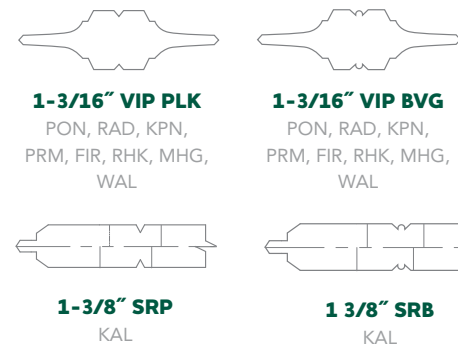

- 20**
PON, RAD, KPN, PRM¹, KAL, FIR, RHK, MHG, WAL
- 102**
PON, RAD, KPN, PRM¹, KAL, FIR, RHK, MHG, WAL
- 802**
PON, RAD, KPN, PRM¹, KAL, FIR, RHK, MHG, WAL
- 820**
PON, RAD, KPN, PRM¹, KAL, FIR, RHK, MHG, WAL

¹ Specie is primed pine unless otherwise noted.

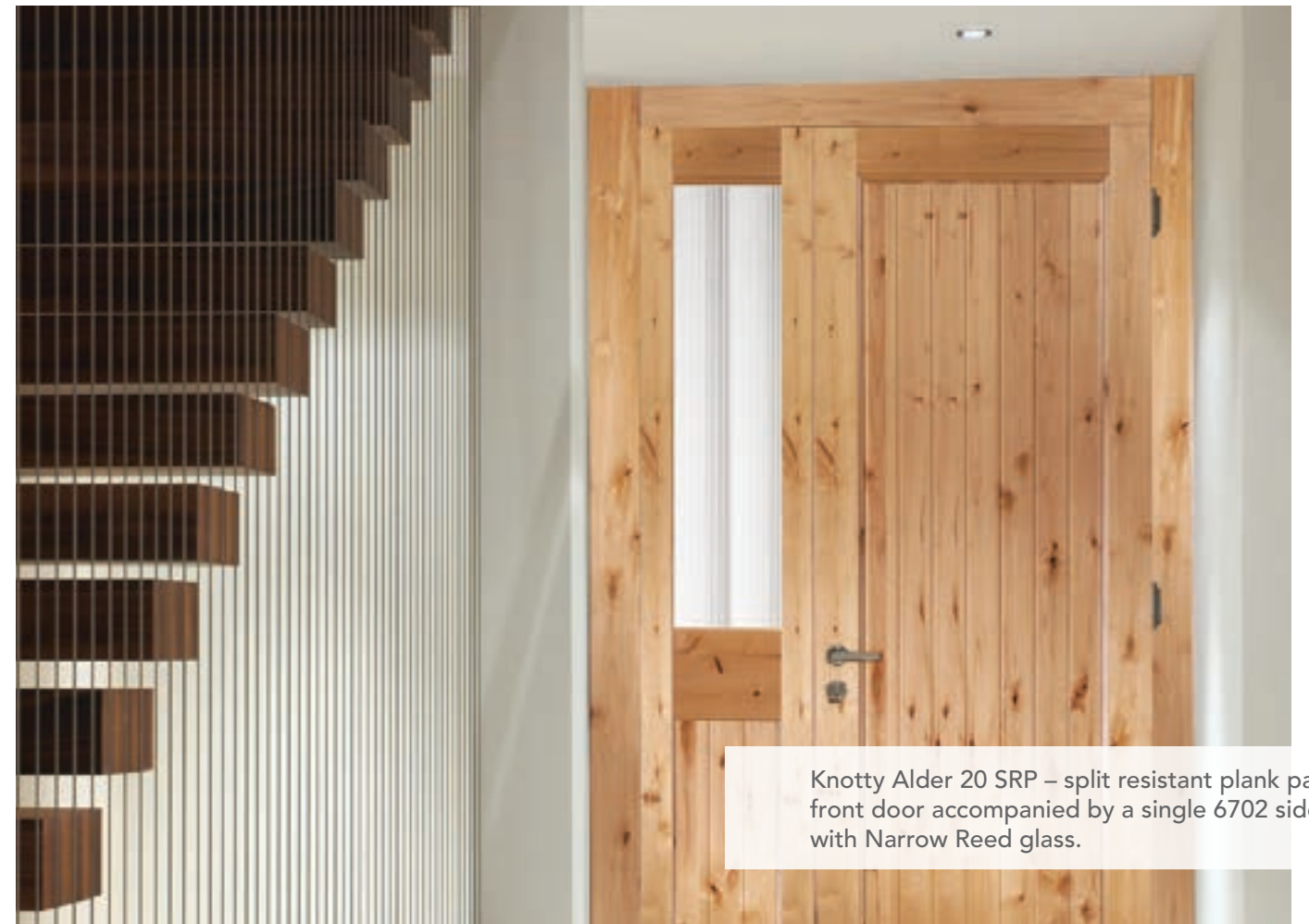

Knotty Alder 20 SRP – split resistant plank panel front door accompanied by a single 6702 sidelight with Narrow Reed glass.

EXTERIOR

RAISED PANEL DOORS

SPECIFICATIONS

- 6'8", 7'0" and 8'0" heights
- 2'0" to 3'0" widths
- 1-3/4" thickness
- Square, Arch and Eyebrow Tops
- Fire Rated Available

PANEL OPTIONS

1-3/16" VIP PLK PON, RAD, KPN, PRM, FIR, RHK, MHG, WAL	1-3/16" VIP BVG PON, RAD, KPN, PRM, FIR, RHK, MHG, WAL	3/4" DBH FIR, RHK, MGH
9/16" RP PON, RAD, KPN, PRM	9/16" DBH PON, RAD, KPN, PRM	1-3/16" VIP PON, RAD, KPN, PRM, FIR, RHK, MHG, WAL
3/4" DBH PLK FIR, RHK, MHG, WAL	3/4" DBH BVG FIR, RHK, MHG, WAL	1-3/8" SRP KAL
1-3/8" SRR KAL	1-3/8" SRD KAL	

For FIRE rated door information see [page 46](#)

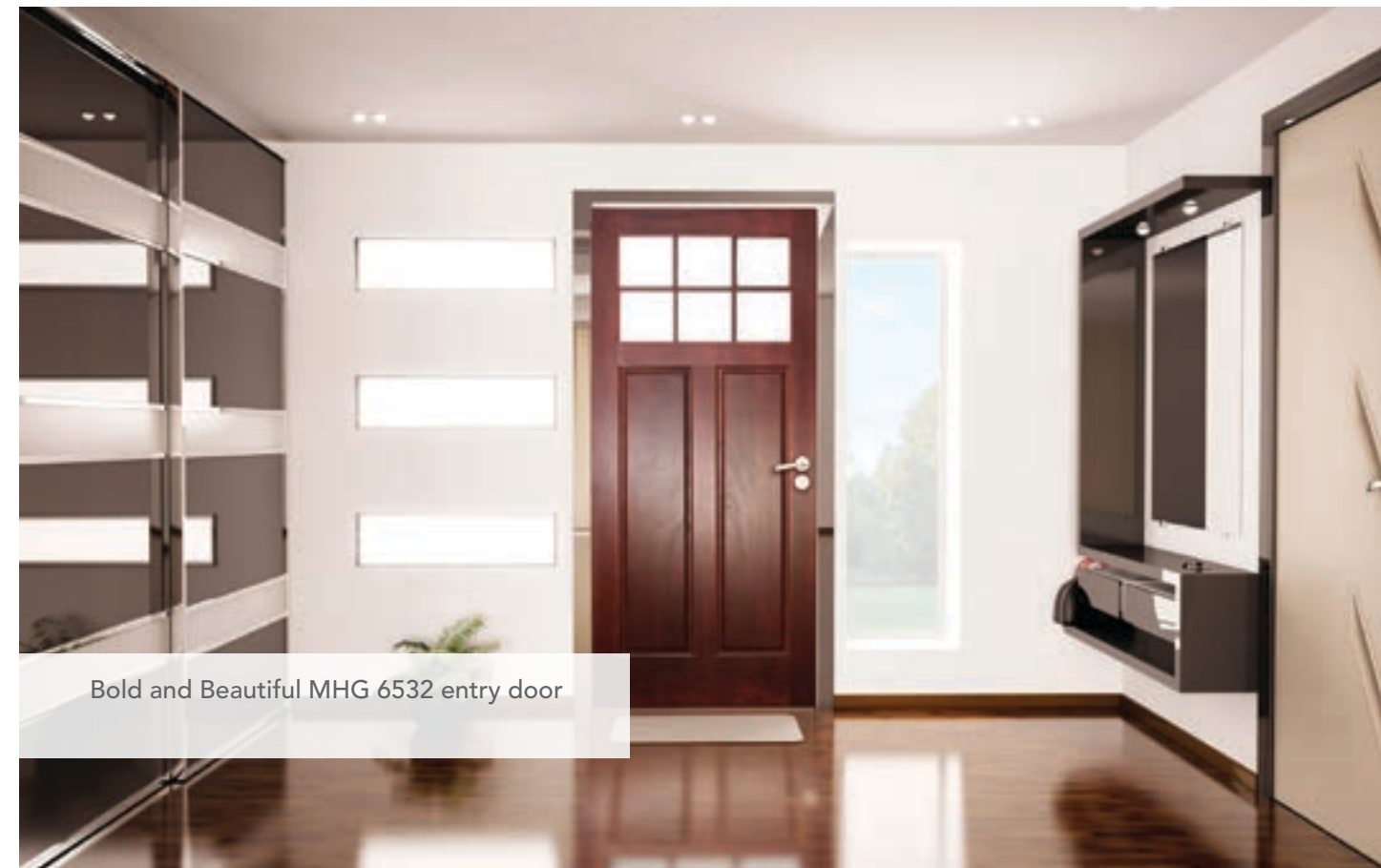

Bold and Beautiful MHG 6532 entry door

20 PON, RAD, KPN, PRM ¹ , KAL, FIR, RHK, MHG, WAL	100 PON, RAD, KPN, PRM ¹	102 PON, RAD, KPN, PRM ¹ , KAL, FIR, RHK, MHG, WAL	103 PON, RAD, KPN, PRM ¹ , KAL, FIR, RHK, MHG, WAL	106 PON, RAD, KPN, PRM ¹ , FIR, RHK, MHG, WAL	107 PON, RAD, KPN, PRM ¹ , KAL, FIR, RHK, MHG, WAL	108 PON, RAD, KPN, PRM ¹ , FIR, RHK, MHG, WAL
109 PON, RAD, KPN, PRM ¹ , FIR, RHK, MHG, WAL	113 PON, RAD, KPN, PRM ¹ , FIR, RHK	131 PON, RAD, KPN, PRM ¹ , FIR, RHK, MHG, WAL	133 PON, RAD, KPN, PRM ¹ , FIR, RHK, MHG, WAL	802 PON, RAD, KPN, PRM ¹ , KAL, FIR, RHK, MHG, WAL	804 PON, RAD, KPN, PRM ¹ , FIR, RHK, MHG, WAL	806 PON, RAD, KPN, PRM ¹
820 PON, RAD, KPN, PRM ¹ , KAL, FIR, RHK, MHG, WAL	822 PON, RAD, KPN, PRM ¹	831 PON, RAD, KPN, PRM ¹ , FIR, RHK, MHG, WAL	833 PON, RAD, KPN, PRM ¹ , FIR, RHK, MHG, WAL			

¹ Specie is primed pine unless otherwise noted.

EXTERIOR GLASS/TDL

SPECIFICATIONS

- 6'8", 7'0" and 8'0" heights
- 2'0" to 3'0" widths
- 1-3/4" thicknesses
- Square and Arch Tops
- Single Glazed and Insulated Low E Glass

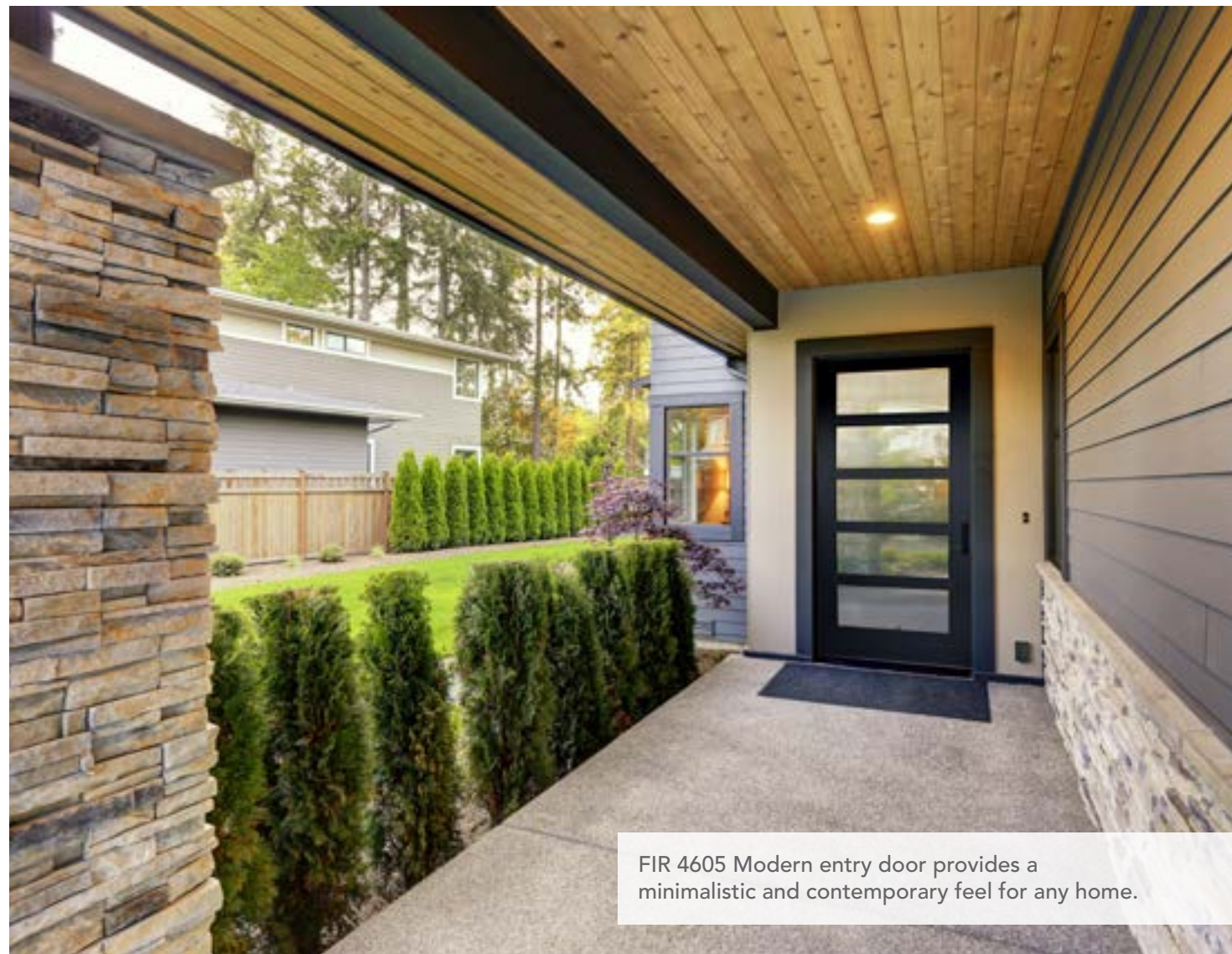

FIR 4605 Modern entry door provides a minimalistic and contemporary feel for any home.



603 / 6603
PON, RAD, KPN,
PRM¹, KAL, FIR,
RHK, MHG, WAL



604 / 6604
PON, RAD, KPN,
PRM¹, KAL, FIR,
RHK, MHG, WAL



605 / 6605
PON, RAD, KPN,
PRM¹, KAL², FIR,
RHK, MHG, WAL



620 / 6620
PON, RAD, KPN,
PRM¹, OAK, MPL,
POP, CHY, KAL²,
FIR, RHK, MHG,
WAL



624 / 6624
PON, RAD, KPN,
PRM¹, KAL, FIR,
RHK, MHG, WAL



625 / 6625
PON, RAD, KPN,
PRM¹, KAL, FIR,
RHK, MHG, WAL



626 / 6626
PON, RAD, KPN,
PRM¹, KAL, FIR,
RHK, MHG, WAL



627 / 6627
PON, RAD, KPN,
PRM¹, KAL, FIR,
RHK, MHG, WAL



628 / 6628
PON, RAD, KPN,
PRM¹, KAL, FIR,
RHK, MHG, WAL



630 / 6630
PON, RAD, KPN,
PRM¹, KAL, FIR,
RHK, MHG, WAL



636 / 6636
PON, RAD, KPN,
PRM¹, KAL, FIR,
RHK, MHG, WAL



668 / 6668
RAD, FIR, RHK,
MHG, WAL



690 / 6690
PON, RAD, KPN,
PRM¹, KAL, FIR,
RHK, MHG, WAL



824 / 6824
PON, RAD, KPN,
PRM¹, KAL, FIR,
RHK, MHG, WAL



836 / 6836
PON, RAD, KPN,
PRM¹, KAL, FIR,
RHK, MHG, WAL



840 / 6840
PON, RAD, KPN,
PRM¹, KAL, FIR,
RHK, MHG, WAL



845 / 6845
PON, RAD, KPN,
PRM¹, KAL, FIR,
RHK, MHG, WAL



846 / 6846
PON, RAD, KPN,
PRM¹, KAL, FIR,
RHK, MHG, WAL



847 / 6847
PON, RAD, KPN,
PRM¹, KAL, FIR,
RHK, MHG, WAL



848 / 6848
PON, RAD, KPN,
PRM¹, KAL, FIR,
RHK, MHG, WAL

¹ Specie is primed pine unless otherwise noted.

² Species only available in I.G. Low E Glass.

EXTERIOR

SASH DOORS

SPECIFICATIONS

- 6'8", 7'0" and 8'0" heights
- 2'0" to 3'0" widths
- 1-3/4" thickness
- Square, Arch and Eyebrow Tops

- Single Glazed and Insulated Low E Glass
- KAL raised panel doors have tapered block sticking

¹ Specie is primed pine unless otherwise noted.

PANEL OPTIONS

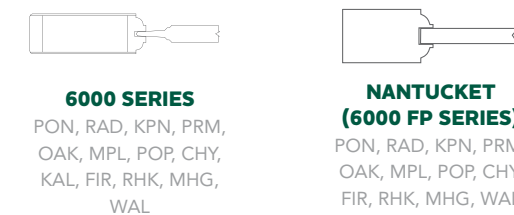
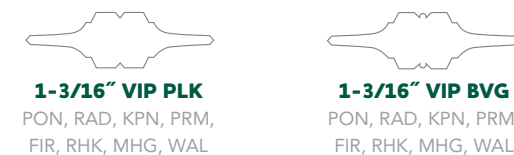
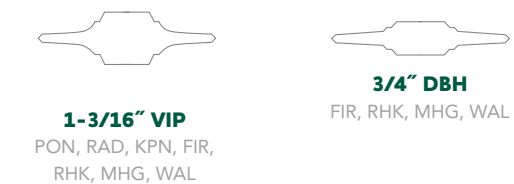

512 / 6512
PON, RAD, KPN, PRM¹, KAL, FIR, RHK, MHG, WAL

513 / 6513
PON, RAD, KPN, PRM¹, KAL, FIR, RHK, MHG, WAL

514 / 6514
PON, RAD, KPN, PRM¹, KAL, FIR, RHK, MHG, WAL

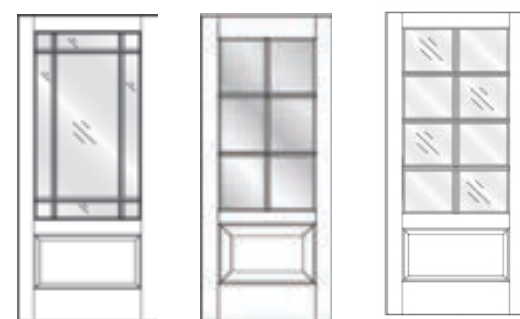

515 / 6515
PON, RAD, KPN, PRM¹, KAL, FIR, RHK, MHG, WAL

516 / 6516
PON, RAD, KPN, PRM¹, KAL, FIR, RHK, MHG, WAL

518 / 6518
PON, RAD, KPN, PRM¹, KAL, FIR, RHK, MHG, WAL



547 / 6547
RAD, FIR, RHK, MHG, WAL

548 / 6548
RAD, FIR, RHK, MHG, WAL

549 / 6549
RAD, FIR, RHK, MHG, WAL

551 / 6551
PON, RAD, KPN, PRM¹, KAL, FIR, RHK, MHG, WAL

558 / 6558
PON, RAD, KPN, PRM¹, FIR, RHK, MHG, WAL

559 / 6559
PON, RAD, KPN, PRM¹, KAL, FIR, RHK, MHG, WAL

561 / 6561
PON, RAD, KPN, PRM¹, KAL, FIR, RHK, MHG, WAL



562 / 6562
PON, RAD, KPN, PRM¹, KAL, FIR, RHK, MHG, WAL

563 / 6563
PON, RAD, KPN, PRM¹, FIR, RHK, MHG, WAL

567 / 6567
PON, RAD, KPN, PRM¹, FIR, RHK, MHG, WAL

568 / 6568
RAD, FIR, RHK, MHG, WAL

4517
RAD, FIR, RHK, MHG, WAL

4517A
RAD, FIR, RHK, MHG, WAL

4568
RAD, FIR, RHK, MHG, WAL



569 / 6569
RAD, FIR, RHK, MHG, WAL

570 / 6570
PON, RAD, KPN, PRM¹, FIR, RHK, MHG, WAL

571 / 6571
PON, RAD, KPN, PRM¹, FIR, RHK, MHG, WAL

572 / 6572
PON, RAD, KPN, PRM¹, FIR, RHK, MHG, WAL

573 / 6573
PON, RAD, KPN, PRM¹, FIR, RHK, MHG, WAL, KAL

581 / 6581
PON, RAD, KPN, PRM¹, FIR, RHK, MHG, WAL, KAL

596 / 6596
PON, RAD, KPN, PRM¹, FIR, RHK, MHG, WAL



598 / 6598
PON, RAD, KPN,
PRM¹, FIR, RHK,
MHG, WAL

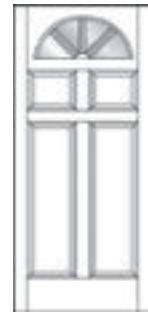

600 / 6600
PON, RAD, KPN,
PRM¹, FIR, RHK,
MHG, WAL



612 / 6612
PON, RAD, PRM¹,
FIR, RHK, MHG,
WAL



615 / 6615
PON, RAD, PRM¹,
FIR, RHK, MHG,
WAL



812 / 6812
PON, RAD, KPN,
PRM¹, KAL, FIR,
RHK, MHG, WAL



813 / 6813
PON, RAD, KPN,
PRM¹, KAL, FIR,
RHK, MHG, WAL



814 / 6814
PON, RAD, KPN,
PRM¹, KAL, FIR,
RHK, MHG, WAL



816 / 6816
PON, RAD, KPN,
PRM¹, KAL, FIR,
RHK, MHG, WAL



818 / 6818
PON, RAD, KPN,
PRM¹, KAL, FIR,
RHK, MHG, WAL



844 / 6844
PON, RAD, KPN,
PRM¹, KAL, FIR,
RHK, MHG, WAL



851 / 6851
PON, RAD, KPN,
PRM¹, KAL, FIR,
RHK, MHG, WAL



859 / 6859
PON, RAD, KPN,
PRM¹, KAL, FIR,
RHK, MHG, WAL



861 / 6861
PON, RAD, KPN,
PRM¹, KAL, FIR,
RHK, MHG, WAL



862 / 6862
PON, RAD, KPN,
PRM¹, KAL, FIR,
RHK, MHG, WAL

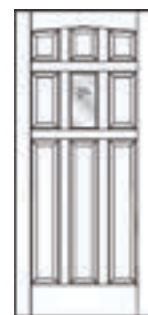

**2045 /
6045**
FIR, RHK, MHG,
WAL



MHG 4605 W

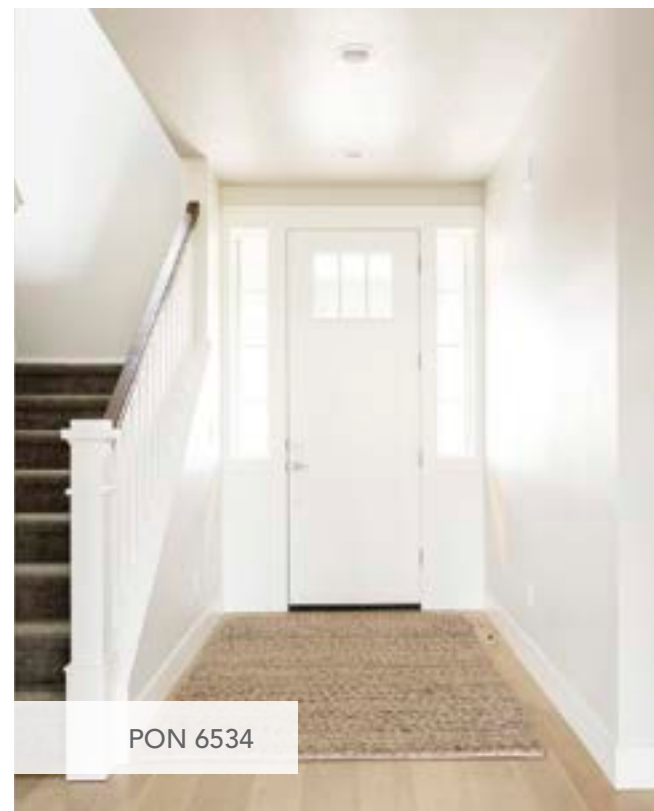

PON 6534



KAL 4532

EXTERIOR CRAFTSMAN DOORS

SPECIFICATIONS

- 6'8", 7'0" & 8'0" heights
- 2'0" to 3'0" widths
- 1-3/4" thickness
- Square and Arch Tops
- All 8/0 doors will have additional glass rows. (6/8 configuration available in 8/0 as custom)
- Raised Panel
- Flat Panel
- Insulated Low E Glass
- KAL raised panel doors have tapered block sticking

DENTIL SHELF OPTION



KAL, FIR, RHK, MHG, WAL

*MDO exterior rated core

EXTERIOR PANEL OPTIONS



3/4" DBH
FIR, RHK, MHG, WAL



3/4" DBH PLK
FIR, RHK, MHG, WAL

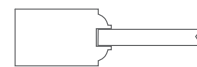

NANTUCKET (6000 FP SERIES)*
FIR, RHK, KAL, MHG, WAL



1-3/16" VIP PLK
FIR, RHK, MHG, WAL



3/4" DBH BVG
FIR, RHK, MHG, WAL



1-3/16" VIP
FIR, RHK, MHG, WAL



1-3/16" VIP BVG
FIR, RHK, MHG, WAL

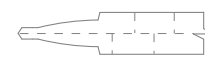

1 3/8" SRR
KAL

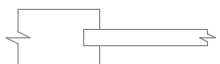

SHAKER (4000 Series)*
FIR, RHK, KAL, MHG, WAL

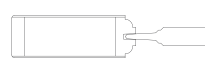

6000 SERIES
PON, RAD, KPN, PRM, KAL, FIR, RHK, MHG, WAL

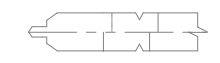

1 3/8" SRD
KAL

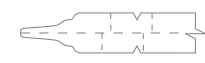

1 3/8" SRD PLK
KAL



6526 / 4526
KAL, FIR, RHK, MHG, WAL

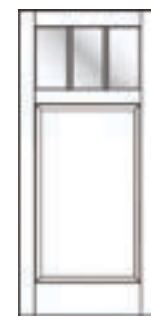

6529 / 4529
KAL, FIR, RHK, MHG, WAL

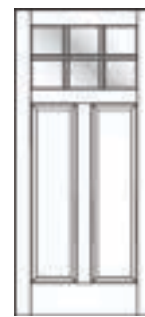

6532 / 4532
KAL, FIR, RHK, MHG, WAL



6553 / 4553
FIR, RHK, MHG, WAL

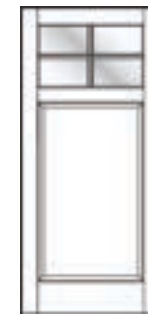

6554 / 4554
KAL, FIR, RHK, MHG, WAL



6555 / 4555
FIR, RHK, MHG, WAL



6556 / 4556
FIR, RHK, MHG, WAL



6557 / 4557
KAL, FIR, RHK, MHG, WAL



6826 / 4826
KAL, FIR, RHK, MHG, WAL



6829 / 4829
KAL, FIR, RHK, MHG, WAL



6832 / 4832
KAL, FIR, RHK, MHG, WAL



6834 / 4834
KAL, FIR, RHK, MHG, WAL



6835 / 4835
FIR, RHK, MHG, WAL



6837 / 4837
FIR, RHK, MHG, WAL



6838 / 4838
KAL, FIR, RHK, MHG, WAL



6839 / 4839
FIR, RHK, MHG, WAL



6839 / 4839
FIR, RHK, MHG, WAL



6534 / 4534
KAL, FIR, RHK, MHG, WAL



6535 / 4535
FIR, RHK, MHG, WAL



6537 / 4537
FIR, RHK, MHG, WAL



6538 / 4538
KAL, FIR, RHK, MHG, WAL



6539 / 4539
FIR, RHK, MHG, WAL



6550 / 4550
KAL, FIR, RHK, MHG, WAL



6552 / 4552
KAL, FIR, RHK, MHG, WAL



6850 / 4850
KAL, FIR, RHK, MHG, WAL



6852 / 4852
KAL, FIR, RHK, MHG, WAL



6853 / 4853
FIR, RHK, MHG, WAL



6854 / 4854
KAL, FIR, RHK, MHG, WAL



6856 / 4856
KAL, FIR, RHK, MHG, WAL



6857 / 4857
KAL, FIR, RHK, MHG, WAL

EXTERIOR SIDELIGHTS

SPECIFICATIONS

- 6'8", 7'0" and 8'0" heights
- 0'10" to 1'6" widths
- 1-3/8" and 1-3/4" thicknesses
- Square and Arch Tops
- Single Glazed and Insulated Low E Glass

PANEL OPTIONS

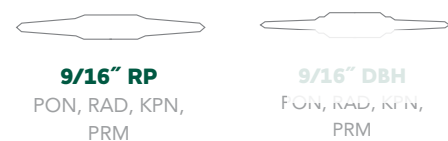

9/16" RP
PON, RAD, KPN,
PRM



9/16" DBH
PON, RAD, KPN,
PRM



1-3/16" VIP
PON, RAD, KPN,
PRM, FIR, RHK, MHG,



WAL
3/4" DBH
FIR, RHK, MHG, WAL



3/4" DBH PLK
FIR, RHK, MHG, WAL



3/4" DBH BVG
FIR, RHK, MHG, WAL



1-3/16" VIP PLK
PON, RAD, KPN,
PRM, FIR, RHK, MHG,
WAL



1-3/16" VIP BVG
PON, RAD, KPN,
PRM, FIR, RHK, MHG,
WAL

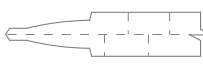

1-3/8" SRR
KAL

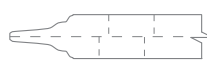

1-3/8" SRD
KAL

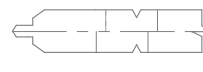

1-3/8" SRP
KAL

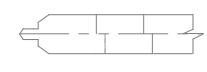

1 3/8" SRF
KAL



PROFILES



1701 / 6701
PON, RAD, KPN,
PRM², KAL¹, FIR,
RHK¹, MHG,
WAL¹



1702 / 6702
PON, RAD,
KPN, PRM²,
KAL¹, FIR,
RHK¹, MHG,
WAL¹



1703 / 6703
PON, RAD, KPN,
PRM², KAL¹, FIR,
RHK¹, MHG,
WAL¹



1704 / 6704
PON, RAD, KPN,
PRM², KAL¹, FIR,
RHK¹, MHG,
WAL¹



1705 / 6705
PON, RAD, KPN,
PRM², KAL¹, FIR,
RHK¹, MHG,
WAL¹



1706 / 6706
PON, RAD, KPN,
PRM², KAL¹, FIR,
RHK¹, MHG,
WAL¹



1707 / 6707
PON, RAD, KPN,
PRM², KAL¹, FIR,
RHK¹, MHG,
WAL¹



1708 / 6708
PON, RAD, KPN,
PRM², KAL¹, FIR,
RHK¹, MHG,
WAL¹



1709 / 6709
PON, RAD, KPN,
PRM², KAL¹, FIR,
RHK¹, MHG,
WAL¹



1710 / 6710
PON, RAD, KPN,
PRM², KAL¹, FIR,
RHK¹, MHG,
WAL¹



1711 / 6711
PON, RAD, KPN,
PRM², KAL¹, FIR,
RHK¹, MHG,
WAL¹



1712 / 6712
PON, RAD, KPN,
PRM², KAL¹, FIR,
RHK¹, MHG,
WAL¹



1713 / 6713
PON, RAD, KPN,
PRM², KAL¹, FIR,
RHK¹, MHG,
WAL¹



1714 / 6714
PON, RAD, KPN,
PRM², KAL¹, FIR,
RHK¹, MHG,
WAL¹



1801 / 6801
PON, RAD, KPN,
PRM², KAL¹, FIR,
RHK¹, MHG,
WAL¹



1802 / 6802
PON, RAD, KPN,
PRM², KAL¹, FIR,
RHK¹, MHG,
WAL¹



1803 / 6803
PON, RAD, KPN,
PRM², KAL¹, FIR,
RHK¹, MHG,
WAL¹



1804 / 6804
PON, RAD, KPN,
PRM², KAL¹, FIR,
RHK¹, MHG,
WAL¹



1805 / 6805
PON, RAD, KPN,
PRM², KAL¹, FIR,
RHK¹, MHG,
WAL¹



1806 / 6806
PON, RAD, KPN,
PRM², KAL¹, FIR,
RHK¹, MHG,
WAL¹



1807 / 6807
PON, RAD, KPN,
PRM², KAL¹, FIR,
RHK¹, MHG,
WAL¹



1808 / 6808
PON, RAD, KPN,
PRM², KAL¹, FIR,
RHK¹, MHG,
WAL¹



1810 / 6810
PON, RAD, KPN,
PRM², KAL¹, FIR,
RHK¹, MHG,
WAL¹



1811 / 6811
PON, RAD, KPN,
PRM², KAL¹, FIR,
RHK¹, MHG,
WAL¹



1849 / 6849
PON, RAD, KPN,
PRM², KAL¹, FIR,
RHK¹, MHG,
WAL¹



1868 / 6868
PON, RAD, KPN,
PRM², KAL¹, FIR,
RHK¹, MHG,
WAL¹



1869 / 6869
PON, RAD, KPN,
PRM², KAL¹, FIR,
RHK¹, MHG,
WAL¹

¹ Species only available in 1-3/4" thickness.
² Species is primed pine unless otherwise noted.
Not all sizes are available in all options.

EXTERIOR TRANSOMS

SPECIFICATIONS

- 1-3/8" and 1-3/4" thicknesses
- Custom width and height configurations
- Single Glazed and Insulated Low E Glass



Create an unforgettable front door entry with a Mahogany 6514 door coupled with two 6703 sidelights and a 5-lite transom.



1 Lite

PON, RAD, KPN, PRM, KAL¹, FIR, RHK¹, MHG, WAL¹



2 Lite

PON, RAD, KPN, PRM, KAL¹, FIR, RHK¹, MHG, WAL¹



3 Lite

PON, RAD, KPN, PRM, KAL¹, FIR, RHK¹, MHG, WAL¹



4 Lite

PON, RAD, KPN, PRM, KAL¹, FIR, RHK¹, MHG, WAL¹



5 Lite

PON, RAD, KPN, PRM, KAL¹, FIR, RHK¹, MHG, WAL¹

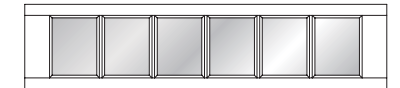

6 Lite

PON, RAD, KPN, PRM, KAL¹, FIR, RHK¹, MHG, WAL¹



7 Lite

PON, RAD, KPN, PRM, KAL¹, FIR, RHK¹, MHG, WAL¹

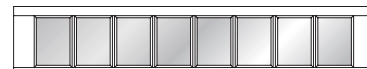

8 Lite

PON, RAD, KPN, PRM, KAL¹, FIR, RHK¹, MHG, WAL¹



9 Lite

PON, RAD, KPN, PRM, KAL¹, FIR, RHK¹, MHG, WAL¹



10 Lite

PON, RAD, KPN, PRM, KAL¹, FIR, RHK¹, MHG, WAL¹

¹Species only available in 1-3/4" thickness.

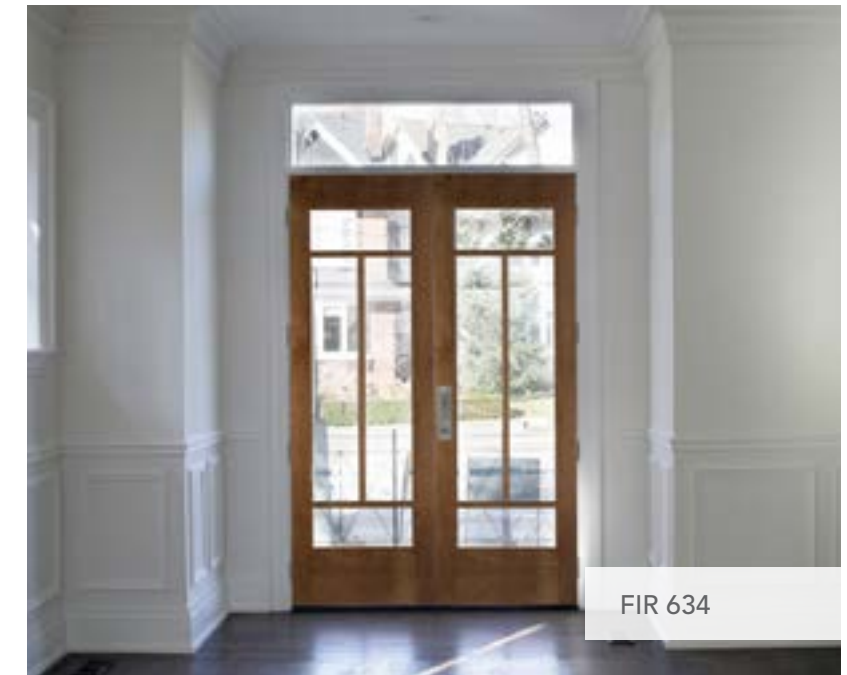

FIR 634

FINISHING

PREPARATION FOR FINISHING

- When staining, a wood conditioner or sander/sealer should be used to help achieve a more uniform finish. (Be sure to follow the wood conditioner manufacturer's instructions closely.)
- Fir doors should be surface treated with acetone product in advance of wood conditioner.
- Before applying the first coat of finish, thoroughly sand the entire surface of the door with 180 grit sandpaper. This crucial step helps remove handling marks, fingerprints, fiber pop, natural grain raise, possible water or liquid marks (if exposed during shipping or while on the job-site during the construction phase) and evenly prepares open wood pores to help produce a more uniform finish.
- **Panels and bars float and may become out of alignment during shipping and handling. Carefully take a block of wood and mallet and tap the components in alignment. Use caution not to damage the door or component during this process.**
- Clean door thoroughly with a cloth after sanding to remove all dust or foreign material. Avoid using compressed air to blow off door as moisture or oil in the air may cause spotting. Avoid using caustic or abrasive cleaners.
- Hang door before finishing it, then remove it to finish properly. Doors stored in stable climate controlled area and should be finished within 72 hours on home site

EXTERIOR FINISHING

STAIN-AND-CLEAR FINISH

When staining, a wood conditioner should be used to help achieve a more uniform finish. (Be sure to follow wood conditioner manufacturer's instructions closely.) The first coat of stain may be a stain-and-sealer, a combination of stain and sealer which colors the door and seals the surface. It is available in a wide range of colors. (Dark color finishes should not be used on doors exposed to prolonged direct sunlight, as some expansion and contraction of door parts may occur. See warranty for detail.) The stain-and-sealer should have an alkyd-resin base. Under no circumstances should a lacquer-based toner or any other lacquer-based finish be used on exterior doors. The second and third coat (two top coats minimum) may be a solvent-borne (oil-base, alkyd resin-base, polyurethane resin-base) or a water-borne (latex resin-base) clear finish. On doors that are glazed, the finish used should be flowed from the wood slightly onto the glass. This will provide assurance against water leakage and protect the glazing compound from drying out.

All stain-and-clear finishes will perform better if protected from the direct effects of sunlight and weathering, and refinishing will not be required as frequently. In areas of high exposure of sunlight and weather a marine grade top coat is recommended.

INTERIOR FINISHING

STAIN-AND-CLEAR FINISH

When staining, a wood conditioner should be used to help achieve a more uniform finish. (Be sure to follow wood conditioner manufacturer's instructions closely.) A solvent-borne finish system is recommended for interior doors and may be a lacquer-based system. For best performance, a minimum of two clear top coats should be used over stains. All six sides of the door must be properly sealed for warranty to apply. Woodgrain Doors have plastic film protection on the glass, removal of plastic film protection immediately after applying the finish is required. Failure to remove the plastic film at this time may cause harm to the glass and will create difficulty in removing the film at a later time. Do not use razor blades or sharp objects to remove the film or clean the glass. These items will scratch the glass.

PAINTED FINISH

Apply 2-3 coats of either oil-base or latex resin-base paints over 1-2 coats of an oil-base primer. PRM with MDF veneer & panels or MDF router carved recommend for ANY painted door application. (Latex or

water base primer may contribute to raised grain and require extra sanding to achieve a smooth finish.) All finishes should be applied in accordance with the manufacturer's instructions. All six sides of the door must be properly sealed for warranty to apply.

CAUTION

Woodgrain Doors cannot evaluate all the available paints and stains, nor customers' specific application requirements.

Your paint dealer should know of suitable finish systems that give satisfactory results in your region. It is highly recommended that top quality finishes be selected, and the application instructions on the container be followed explicitly.

Please do not use metal objects, (razor blades etc.) To remove caulking compound or paint and varnish residue. It is known to scratch the tempered glass. Please do not use compressed air to blow off wood doors, as condensation in the air lines may cause irregular finishing results.

WOODGRAIN DOORS WITH GLASS

Plastic film protection on the glass should be removed immediately after applying the finish. Failure to remove the plastic film at this time may cause harm to the glass and may create difficulty in removing the film. Use caution to avoid scratching the glass while cleaning it. Glass that is scratched due to cleaning is not covered by the warranty. Film should be removed by scoring edges carefully under sticking or profile edge and peeled off by hand. Doors with multiple panes of glass scratched not result of manufacturer defect. SOP instructions for film removal available on request.

GLASS CLEANING AND CARE GUIDELINES

DO:

- Clean glass when dirt and residue appear
- Exercise special care when cleaning coated glass surfaces
- Avoid cleaning tinted and coated glass surfaces in direct sunlight
- Start cleaning at the upper level of glass and continue to lower levels
- Soak the glass surface with clean water and soap solution to loosen dirt and debris
- Use a mild, non-abrasive commercial window cleaning solution
- Use a squeegee to remove all of the cleaning solution
- Dry all cleaning solution from window gaskets, sealants and frame
- Be aware of and follow the glass supplier's specific cleaning recommendations
- Prevent conditions that can damage the glass

DON'T:

- Don't use scrapers of any size or type for cleaning glass
- Don't allow dirt and residue to remain on glass for an extended period of time
- Don't begin cleaning glass without knowing if a coated surface is exposed
- Don't clean tinted or coated glass in direct sunlight
- Don't allow water or cleaning residue to remain on the glass or adjacent materials
- Don't begin cleaning without rinsing excessive dirt and debris
- Don't use abrasive cleaning solutions or materials
- Don't allow metal parts of cleaning equipment to contact the glass
- Don't trap abrasive particles between the cleaning materials and the glass surface
- Don't allow other trades to lean tools or materials against the glass surface
- Don't allow splashed materials to dry on the glass surface

FITTING AND HANGING

- Immediately after cutting and fitting (before hanging), seal all cut surfaces and ends of door with an effective quality sealer. See exterior and interior finishing recommendation for complete instructions.
- Prior to exterior exposure, doors should be finished with complete finish system.
- When hanging door, allow adequate clearance for swelling of door or frame in damp weather. Allow approximately 3/16" clearance for swelling when the door is installed in fully dry conditions. Jambs must be plumb.
- Do not cut doors down in height by more than 2-9/16" (13/16" maximum from top, 1-3/4" from the bottom). Care should be taken in cutting doors down in width (maximum 1/8" each side) to avoid exposing engineered core. Use sharp fine tooth saw for trimming ends of doors.
- Caution must be used to avoid impairing the strength of the door when fitting for locks. Allow at least 1" of wood back of mortise.
- Use three hinges on doors up to 7' in height and four hinges on doors over 7'. Hinges must be set in a straight line to prevent distortion.
- Jambs and stops must be set square and plumb.
- For best performance, any exterior door should be installed under an overhang equal to the height of the door.
- To minimize heat loss and save energy, use weatherstripping.
- Do not use metal objects, (razor blades etc.) to remove caulking compound or paint and varnish residue, it is known to scratch the tempered glass. Please do not use compressed air to blow off wood doors, as condensation in the air lines may cause irregular finishing results.

STORING AND HANDLING

- Do not walk on any door units. Some units contain glass.
- Avoid leaving unfinished doors in direct sunlight. Prolonged exposure to direct sunlight will discolor the wood and bake on the plastic film which protects the glass during the finishing process.
- Avoid dragging doors across one another.
- Keep doors clean.
- Store doors flat on a level surface in a dry, well ventilated interior space.
- Doors should be conditioned to average prevailing relative humidity of the locality before hanging. This generally takes 48 to 72 hours.
- Doors should be delivered to the building site only after the concrete, plaster, stucco, sheet rock work and paint are completely dry.
- Doors should not be subject to abnormal heat, dryness or humidity for prolonged periods. Avoid sudden changes such as forced heat to dry out a building.
- Doors must be finished immediately upon delivery to the job site.
- If the doors are to be stored on the job site, the entire door including top and bottom edges must be sealed with a clear or pigmented based sealer to prevent moisture absorption. All six sides of the door must be properly sealed for warranty to apply.

MAINTENANCE

Your Woodgrain door has been handcrafted to last for years to come. But, like any fine piece of furniture, its finish will require periodic maintenance to keep it looking great and provide proper protection against the elements. Regular finish maintenance is also a requirement of the warranty that is included with every Woodgrain door.

Here are some signs to watch for that may indicate it is time for maintenance:

- Hairline cracks in the top coat of finish.
- Changes in the color of the finish.
- Changes in the texture of the finish, such as flaking or scaling.
- Dullness or chalkiness in the finish.

If you live in a severe climate or your entry receives a lot of direct sunlight from a southern or western exposure, you will want to examine your door's finish often. Depending on these conditions, you may also need to refinish the door more frequently.



KAL 181 PLK- For more barn door designs and options see pages 22-23.

WARRANTY

WOODGRAIN LIMITED WARRANTY INFORMATION

Woodgrain Doors (hereafter Seller) doors are warranted to be of sound material and workmanship and to be free of manufacturing defects which would cause the door to be unfit for ordinary recommended use for the period of twenty-four (24) months on interior doors and twelve months (12) on exterior doors from the date of shipment provided the handling, installation, and finishing proper instructions are followed. Failure to follow these guidelines voids the warranty.

Normal characteristics of kiln dried wood include but are not limited to, minor swelling and shrinking of parts made from wood, raised grain, minor pitch pockets, natural grain and color variations. Natural expansion and contraction of wood occurs with variations in climatic and atmospheric conditions such as humidity and temperature and is not a defect hereunder.

Warp in the plane of the door itself will be considered a defect only if it exceeds one-quarter inch (1/4") when measured as a deviation from a straight edge. Doors over 3-0 wide or 7-0 high are excluded from the warranty against warp. Improper hanging of the door or unsquare door frames are not considered as defects. Louver doors wider than 3-0 wide are not covered for slat warp and bow.

Any doors used in an exterior application must be at least 1 3/4" thick and must be installed under an adequate overhang. An adequate overhang depends on the typical weather conditions of the site where the building is located. This means an overhang of 50% of the height of the doorway in Northern or Eastern exposures (reference illustration where Y= Height of the Doorway and X = Length of Overhang). For doors painted or stained dark colors and/or severe exposure, extreme Southern, Southwestern and Western exposures the overhang must equal the height of the doorway (Y=X) where Y = Height of the Doorway and X = Length of Overhang.

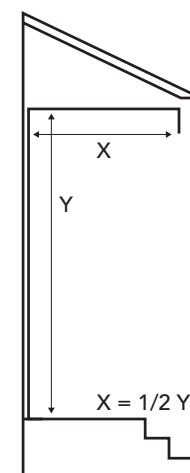

For doors stained or painted black or espresso finishes, X = Y

Any doors found to be defective by the Seller will be repaired or replaced, or the purchase price will be refunded at the option of Woodgrain Doors, provided the handling, installation and finishing instructions have been followed.

An extended warranty period is granted solely for seal failure on insulated glass units (moisture between glass) for a period of ten (10) years from the date of manufacture. At Seller's sole discretion, the replacement door or glass will be shipped FOB from the Woodgrain Doors factory. Seller will not, under any circumstances, be liable for installation, refinishing or painting. Cracked, scratched or broken glass is not covered by this warranty. The glass warranty will be void if the product is not properly installed according to Seller's installation instructions, or is used in or around swimming pools, saunas, sprinkler systems or greenhouse enclosures; or if installed over 5,000 ft. above sea level unless units were ordered with high altitude breather tubes. The warranty on doors will be void if the product is used in or around swimming pools, saunas, sprinkler systems or greenhouse enclosures. No agent, employee or representative of Seller has any authority to bind Seller to any affirmation, representation or warranty concerning Seller's products, except as expressly stated herein.

The foregoing is in lieu of all other expressed warranties. All implied warranties of merchantability or fitness for a particular purpose are hereby limited in duration up to the two-year period stated herein. The liability of Woodgrain Doors is expressly limited to replacement or repair of the defects of the door, or refunding at its option. Woodgrain Doors will not be liable for any other expense, injury, loss or damage, whether direct or consequential, arising in connection with the sale or use of, or inability to use, any product of Woodgrain Doors, for any purpose. No purchaser shall be entitled to consequential damages as defined in the Uniform Commercial Code. Final determination of whether or not a defect exists shall be made solely by Seller in accordance with procedures established by Seller.

PRM 4102 - For other flat panel primed Doors see pages 18 and 19.



**BEAUTY.
STRENGTH.
DURABILITY.**

WWW.WOODGRAINDOORS.COM

September 2019